

技术要求:

- 1、必须按照设计、工艺要求及本规定和有关标准进行装配;
- 2、所有零部件(包括外购、外协件)必须具有检验合格证方能进行装配;
- 3、零件在装配前必须清理和清洗干净,不得有毛刺、飞边、氧化皮、锈蚀、切屑、砂粒、灰尘和油污等,并应符合相应清洁度要求;
- 4、装配过程中零件不得磕碰、划伤和锈蚀;
- 5、油漆未干的零件不得进行装配;
- 6、相对运动的零件,装配时接触面间应加润滑油脂;
- 7、各零、部件装配后相对位置应准确。

业务代码:

4	GB-T-70.1-2000-S-NL-M3X8	不锈钢内六角杯头螺丝M3X8	SUS 304	8	0.001	
3	YG-K23C01-0000-002	K23C红色塑料端盖	ABS	2	0.027	
2	YG-K23C-0000-003	挡板	5052-H32	2	0.042	
1	YG-K23C-0000-001	壳体	6063-T5	2	0.126	
序号 (Item)	图号 (Drawing Number)	名称 (Part Name)	材料 (Material)	数量 (QTY)	单重 (Weight)	备注 (Note)

Tolerances (未注公差):		Material (材料): (装配图)		YONGU 永固		
0.5 to 6 ± 0.1	6 to 30 ± 0.2	Weight: (重量) (Kg):	0.397			
30 to 120 ± 0.3	120 to 400 ± 0.4	Protection: (表面处理):		Drawing Number (图号):		
Break sharp edges (未注锐边倒角):		Part Name (零/部件名称):		YG-K23C-0000-000		
Ch 0.05 to 0.25 x45°	Angular tolerances (未注角度公差):	K23C壳体		Date (日期): 2020.12.14		
Position tolerances (未注位置公差): ±0.05	<6° ± 10'	Drawn by (绘图): 江瑞章		Size: (图幅): A1		
	<30° + 20'	Check by (校对):		Date (日期):		
	<120° ± 30'	Signature by (批准):		Scale (比例): 1:1		
	>120° ± 1°	Date (日期):		Revision (版本): A1		
				Sheet (页数): 1 / 1		

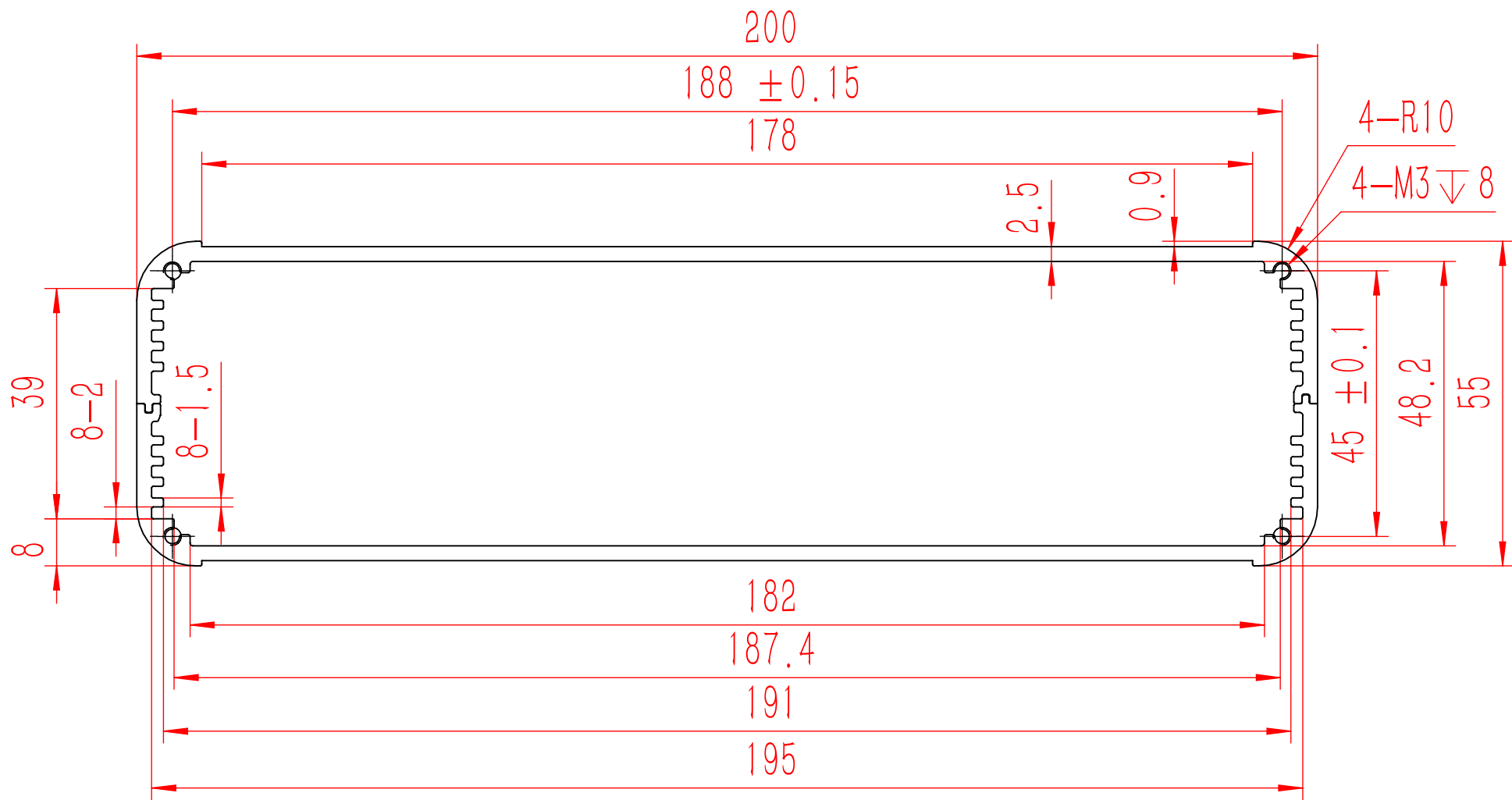

Tolerances (未注公差): 0.5 to 6 ± 0.1 6 to 30 ± 0.2 30 to 120 ± 0.3 120 to 400 ± 0.4	Material (材料): (装配图)	YONGU 	
	Weight: (重量) (Kg) 0.574		
Break sharp edges (未注锐边倒角): Ch 0.05 to 0.25 x45°	Protection: (表面处理):	Drawing Number (图号): YG-K23-JMT	
	Position tolerances (未注位置公差): ±0.05	Part Name (零/部件名称): YG-K23截面图	Size: (图幅): A4
Angular tolerances (未注角度公差): <6° ± 10' <30° ± 20' <120° ± 30' >120° ± 1°	Drawn by (绘图): 江瑞章	Date (日期): 2020.12.14	 Sheet (页数): 1 / 1
	Check by (校对):	Date (日期):	
	Signature by (批准):	Date (日期):	Revision (版本): A1

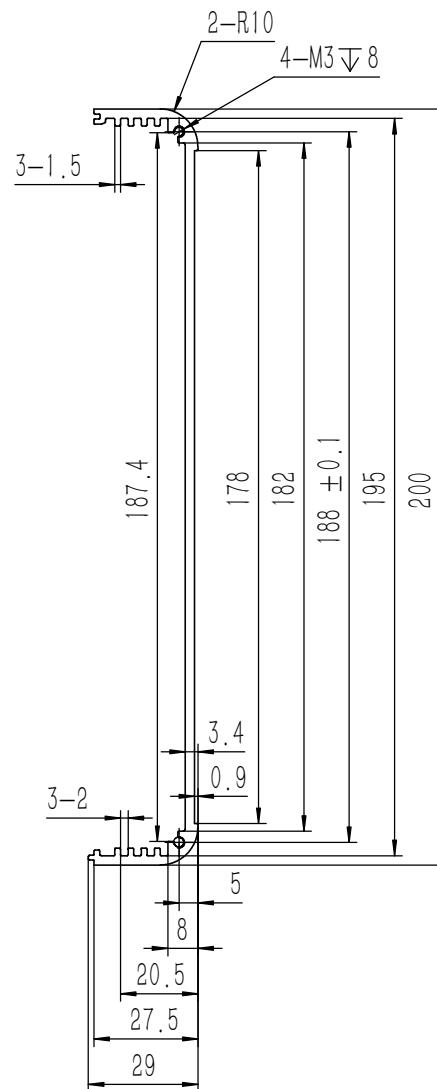
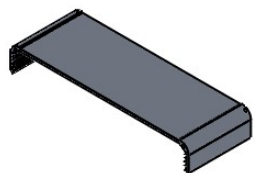
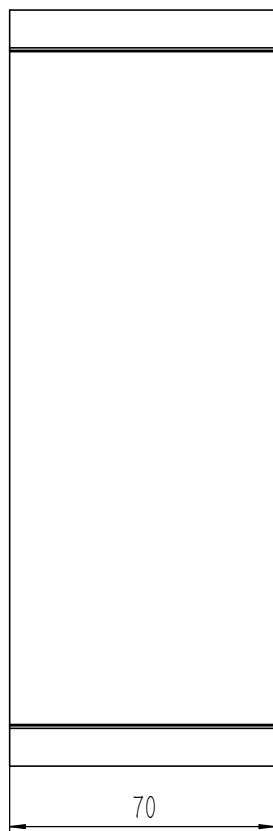

技术要求:

- 1、未注倒角R0.3
- 2、零件加工表面不应有划痕、擦伤等损伤零件表面的缺陷;
- 3、去除毛刺飞边,锐角倒钝;
- 4、未标注尺寸见3D数模。

业务代码:

Break sharp edges (未注锐边倒角): Ch 0.05 to 0.25 x45°	Angular tolerances (未注角度公差): <6° ± 10' <30° ± 20' <120° ± 30' >120° ± 1°
Position tolerances (未注位置公差): ±0.05	

Tolerances (未注公差): 0.5 to 6 ± 0.1 6 to 30 ± 0.2 30 to 120 ± 0.3 120 to 400 ± 0.4		Material (材料): 6063-T5	YONGU 		
		Weight: (重量) (Kg): 0.126			
		Protection: (表面处理):	Part Name (零/部件名称): 壳体		
		Part Name (零/部件名称):	Drawing Number (图号): YG-K23C-0000-001		
		Part Name (零/部件名称):	Drawn by (绘图): 江瑞章	Date (日期): 2020.12.14	Size: (图幅): A2
		Part Name (零/部件名称):	Check by (校对):	Date (日期):	Scale (比例): 1:1
		Part Name (零/部件名称):	Signature by (批准):	Date (日期):	Revision (版本): A1
		Part Name (零/部件名称):			Sheet (页数): 1 / 1

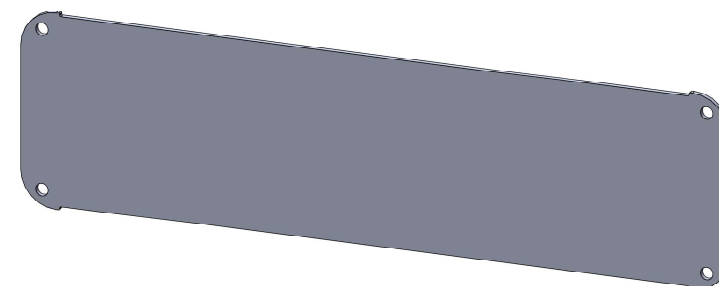
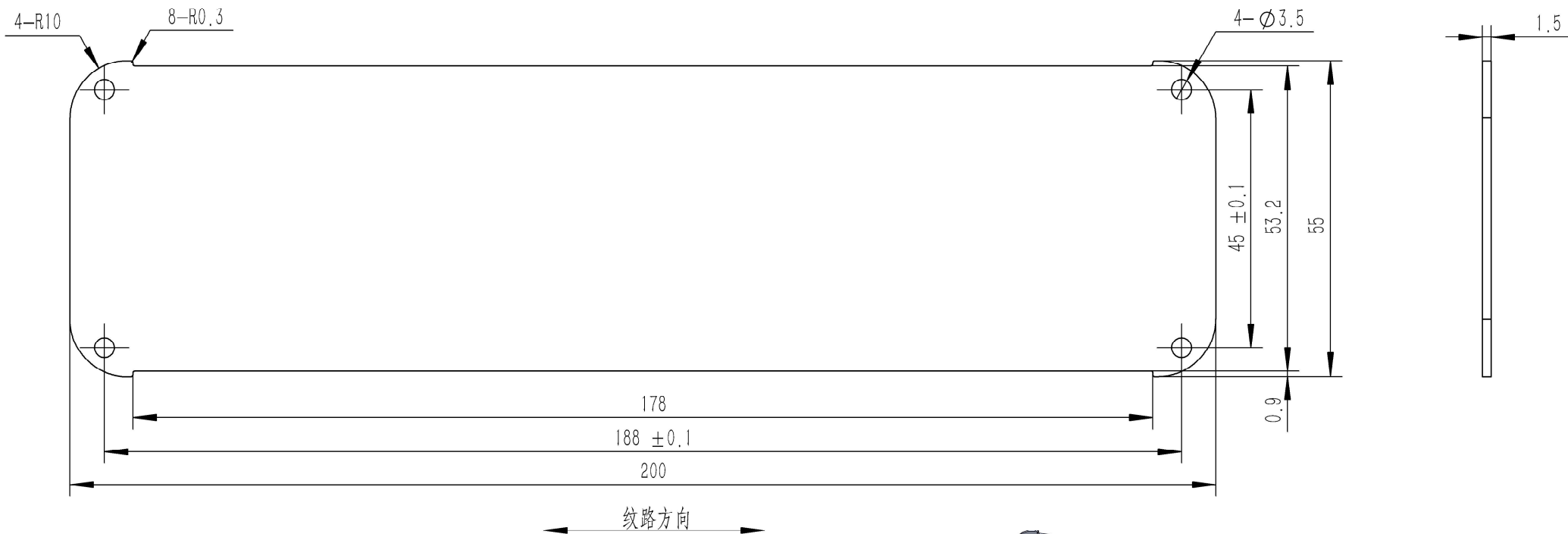

技术要求:

- 1、零件加工表面不应有划痕、擦伤等损伤零件表面的缺陷;
- 2、去除毛刺飞边, 锐角倒钝;
- 3、未标注尺寸见3D数模。

业务代码:

Break sharp edges (未注锐边倒角): Ch 0.05 to 0.25 x45°	Angular tolerances (未注角度公差): <6° ± 10' <30° ± 20' <120° ± 30' >120° ± 1°
Position tolerances (未注位置公差): ±0.05	

Tolerances (未注公差): 0.5 to 6 ± 0.1 6 to 30 ± 0.2 30 to 120 ± 0.3 120 to 400 ± 0.4	Material (材料): 5052-H32	YONGU 永固	
	Weight: (重量) (Kg) 0.042		
	Part Name (零/部件名称): 挡板	Drawing Number (图号): YG-K23C-0000-003	
	Drawn by (绘图): 江瑞章	Date (日期): 2020.12.14	Size: (图幅): A4
	Check by (校对):	Date (日期):	Scale (比例): 1:1
	Signature by (批准):	Date (日期):	Revision (版本): A1
			Sheet (页数): 1 / 1

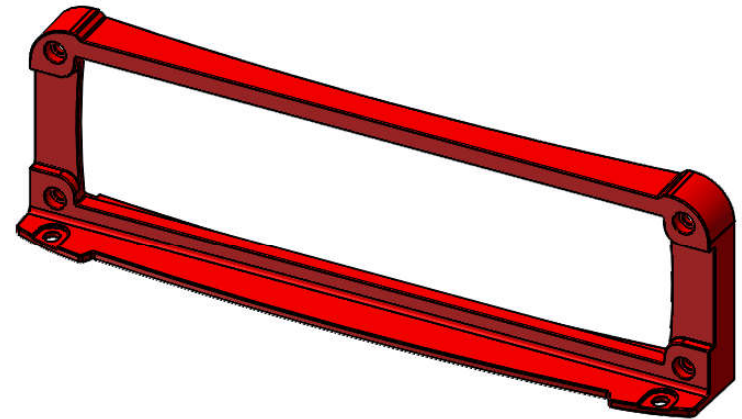
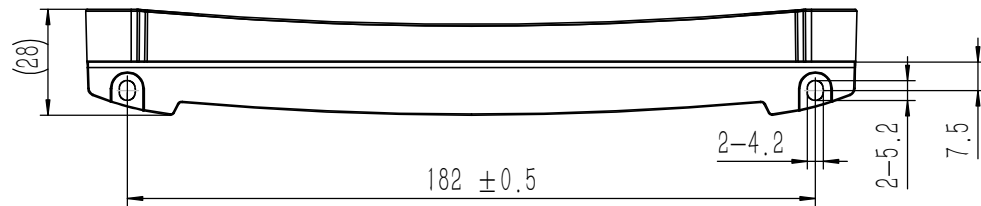
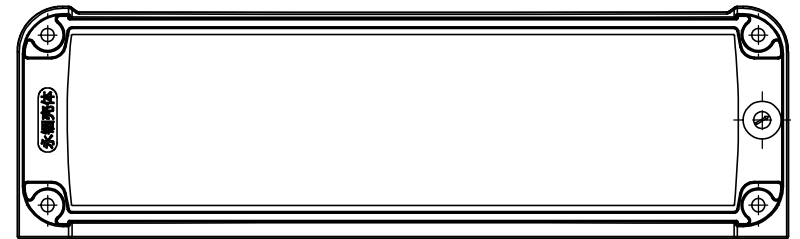
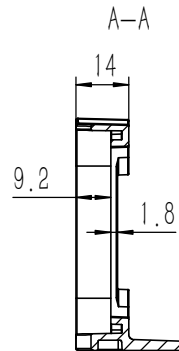
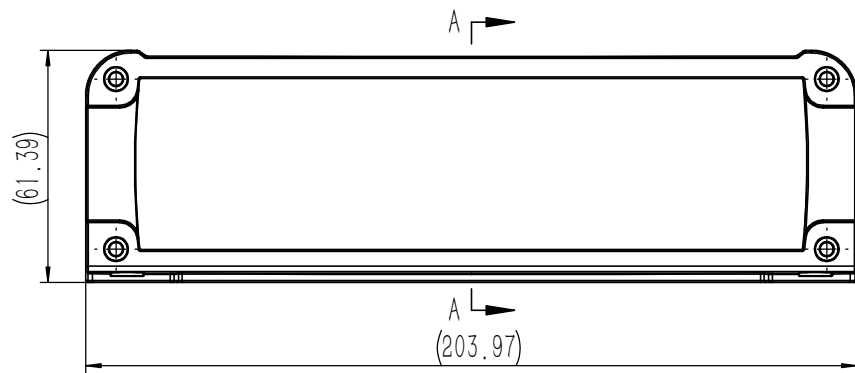

技术要求:
 1、零件表面不允许有收缩、凹陷、熔接痕、水纹、顶白及飞边等缺陷
 2、未标注尺寸见3D数模。

业务代码:

Tolerances (未注公差): 0.5 to 6 ± 0.1 6 to 30 ± 0.2 30 to 120 ± 0.3 120 to 400 ± 0.4	Material (材料):	ABS	YONGU 
	Weight: (重量) (Kg):	0.027	
Break sharp edges (未注锐边倒角): Ch 0.05 to 0.25 x45° Position tolerances (未注位置公差): ±0.05	Protection: (表面处理):	喷橡胶漆	Drawing Number (图号): YG-K23C01-0000-002
	Angular tolerances (未注角度公差): <6° ± 10' <30° ± 20' <120° ± 30' >120° ± 1°	Part Name (零/部件名称):	K23C红色塑料端盖
	Drawn by (绘图):	江瑞章	Date (日期): 2020.12.14
	Check by (校对):		Date (日期):
	Signature by (批准):		Date (日期):
			Sheet (页数): 1 / 1