

5	GB-T-70.1-2000-S-NL-M3X8	不锈钢内六角杯头螺丝M3X8	SUS 304	2	0.001	
4	GB-T-819.1-2000-C-BE-M3X8	碳钢发黑十字沉头螺丝M3X8	普通碳钢	2	0.0005	
3	YG-W07C-0000-003	后面板	5052-H32	1	0.023	
2	YG-W07C-0000-002	前面板	5052-H32	1	0.051	
1	YG-W07C-0000-001	壳体	6063-T5	1	0.181	
序号	图号	名称	材料	数量	单重	备注

Tolerances (未注公差):		Material (材料): (装配图)		YONGU 永固	
0.5 to 6 ± 0.1	Weight: (重量) (Kg) 0.258	Protection: (表面处理):			
6 to 30 ± 0.2	Part Name (零/部件名称):				
30 to 120 ± 0.3	W07C功放		Drawing Number (图号): YG-W07C-0000-000		
120 to 400 ± 0.4	Angular tolerances (未注角度公差):		Size (图幅): A3		
Break sharp edges (未注锐边倒角): Ch 0.05 to 0.25 x45°	<6° ± 10'	Drawn by (绘图): 莫永康	Date (日期): 2020.05.16	Sheet (页数): 1 / 1	
Position tolerances (未注位置公差): ±0.05	<30° ± 20'	Check by (校对):	Date (日期):	Scale (比例): 1:1	
	<120° ± 30'	Signature by (批准):	Date (日期):	Revision (版本): A1	
	>120° ± 1°				

技术要求:

- 1、必须按照设计、工艺要求及本规定和有关标准进行装配;
- 2、所有零部件(包括外购、外协件)必须具有检验合格证方能进行装配;
- 3、零件在装配前必须清理和清洗干净,不得有毛刺、飞边、氧化皮、锈蚀、切屑、砂粒、灰尘和油污等,并应符合相应清洁度要求;
- 4、装配过程中零件不得磕碰、划伤和锈蚀;
- 5、油漆未干的零件不得进行装配;
- 6、相对运动的零件,装配时接触面间应加润滑油脂;
- 7、各零、部件装配后相对位置应准确。

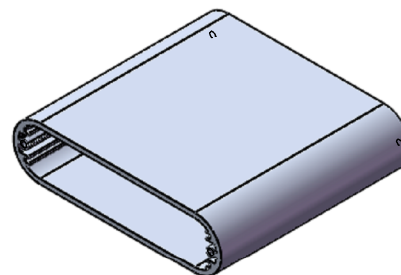
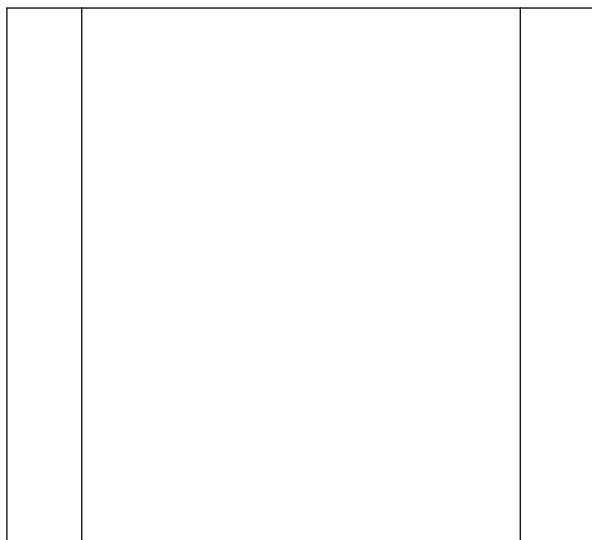
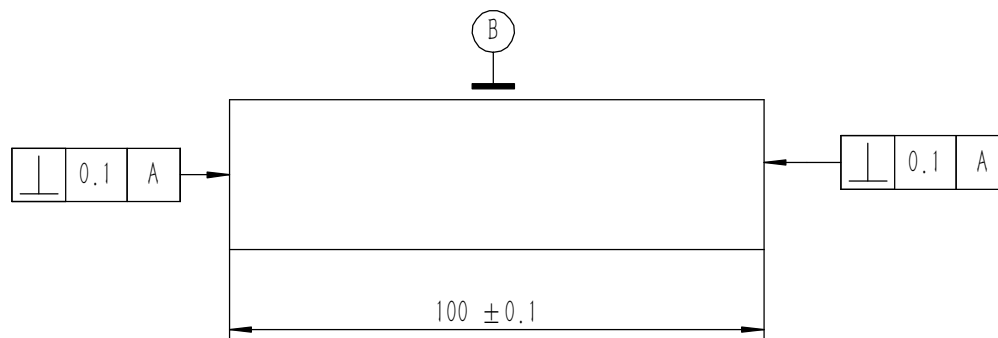
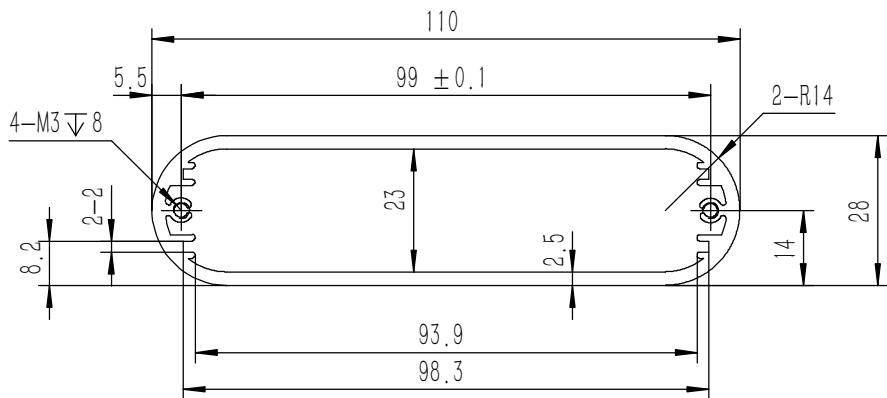

技术要求:

- 1、零件加工表面不应有划痕、擦伤等损伤零件表面的缺陷;
- 2、去除毛刺飞边,锐角倒钝;
- 3、未标注尺寸见3D数模。

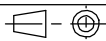
Tolerances (未注公差): 0.5 to 6 ± 0.1 6 to 30 ± 0.2 30 to 120 ± 0.3 120 to 400 ± 0.4	Material (材料):	6063-T5		YONGU 
	Weight: (重量) (Kg)	0.181		
Break sharp edges (未注锐边倒角): Ch 0.05 to 0.25 x45°	Protection: (表面处理):			Drawing Number (图号): YG-W07C-0000-001
	Angular tolerances (未注角度公差): <6° ± 10' <30° ± 20' <120° ± 30' >120° ± 1°	Part Name (零/部件名称):	壳体	
Position tolerances (未注位置公差): ±0.05	Drawn by (绘图):	莫永康	Date (日期): 2020.05.16	Size (图幅): A3 
	Check by (校对):		Date (日期):	Scale (比例): 1:1
	Signature by (批准):		Date (日期):	Revision (版本): A1
				Sheet (页数): 1 / 1

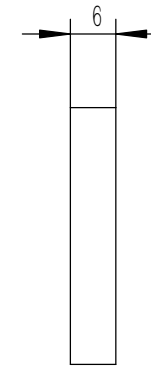
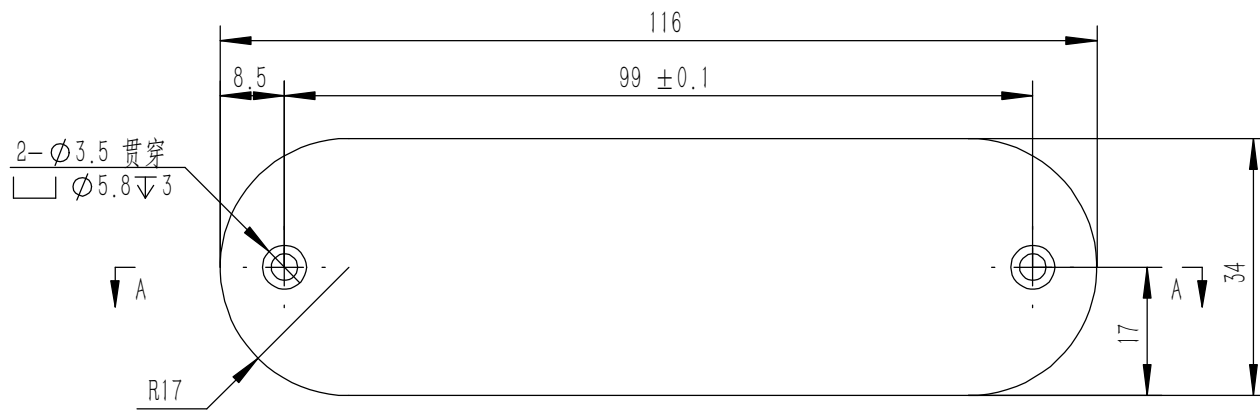

A-A

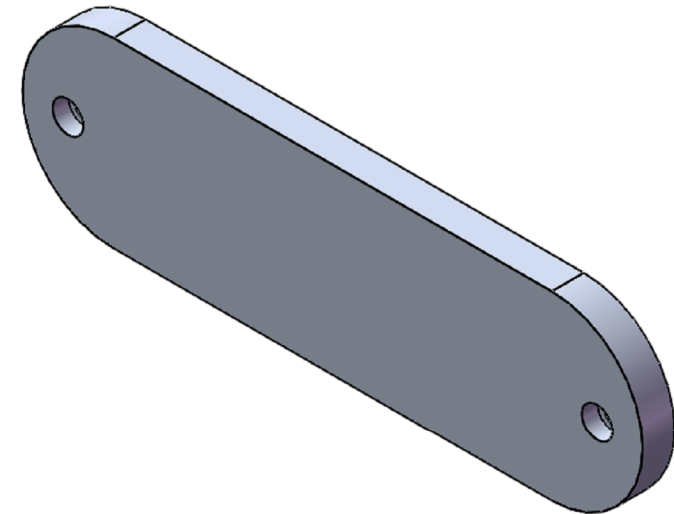
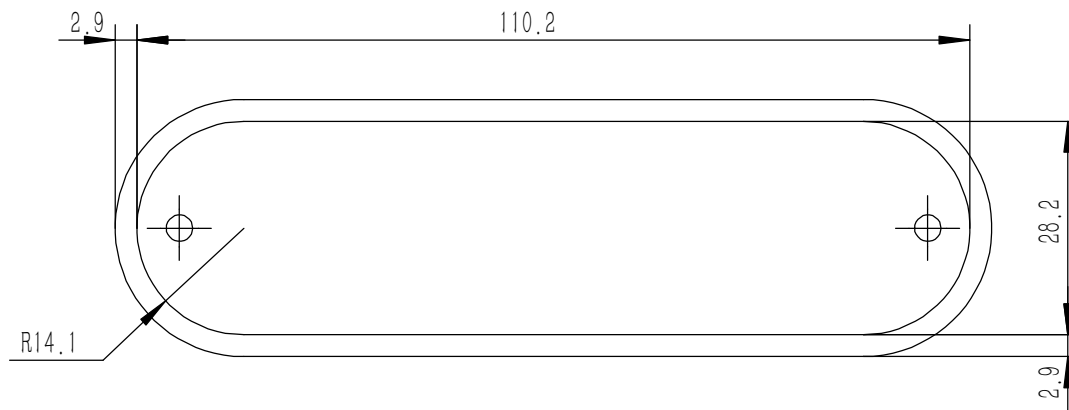
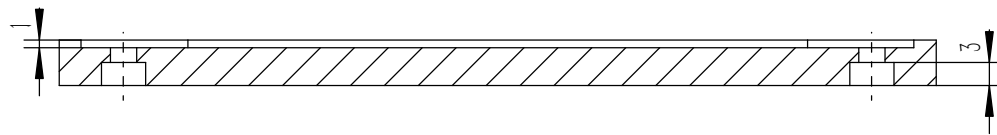

技术要求:

- 1、零件加工表面不应有划痕、擦伤等损伤零件表面的缺陷;
- 2、去除毛刺飞边,锐角倒钝;
- 3、未标注尺寸见3D数模。

Tolerances (未注公差): 0.5 to 6 ± 0.1 6 to 30 ± 0.2 30 to 120 ± 0.3 120 to 400 ± 0.4	Material (材料): 5052-H32	YONGU 永固		
	Weight: (重量) (Kg) 0.051			
Break sharp edges (未注锐边倒角): Ch 0.05 to 0.25 x45°	Protection: (表面处理):	Part Name (零/部件名称): 前面板		
	Position tolerances (未注位置公差): ±0.05	Angular tolerances (未注角度公差): <6° ± 10' <30° ± 20' <120° ± 30' >120° ± 1°	Date (日期): 2020.05.16	Drawing Number (图号): YG-W07C-0000-002
	Drawn by (绘图): 莫永康	Date (日期):	Scale (比例): 1:1	Sheet (页数): 1 / 1
	Check by (校对):	Date (日期):	Revision (版本): A1	
	Signature by (批准):	Date (日期):		

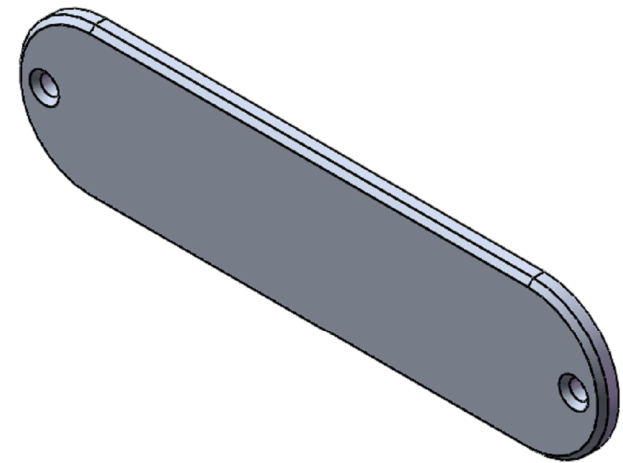
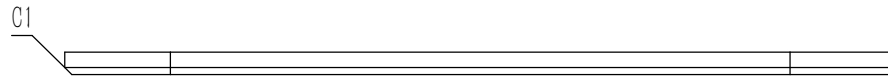
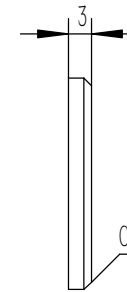
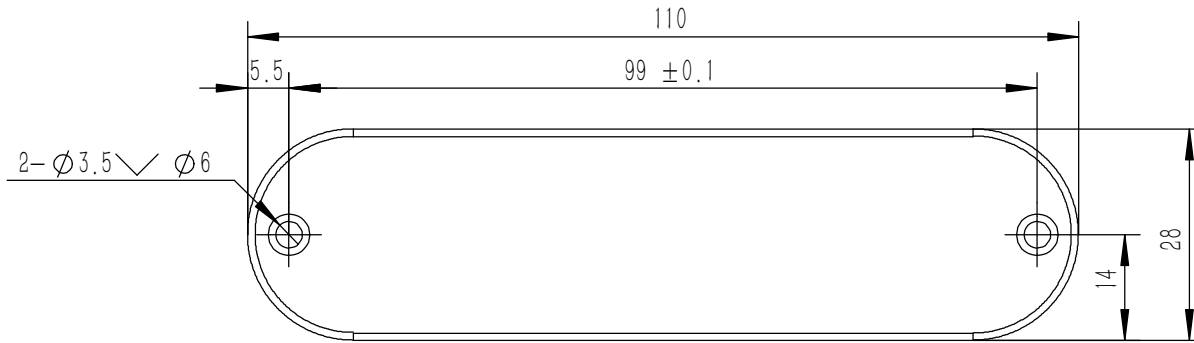

技术要求:

- 1、零件加工表面不应有划痕、擦伤等损伤零件表面的缺陷;
- 2、去除毛刺飞边,锐角倒钝;
- 3、未标注尺寸见3D数模。

Tolerances (未注公差): 0.5 to 6 ± 0.1 6 to 30 ± 0.2 30 to 120 ± 0.3 120 to 400 ± 0.4	Material (材料):	5052-H32		YONGU 
	Weight: (重量) (Kg)	0.023		
Break sharp edges (未注锐边倒角): Ch 0.05 to 0.25 x45°	Protection: (表面处理):			
	Position tolerances (未注位置公差): ± 0.05	Part Name (零/部件名称):	后面板	
Angular tolerances (未注角度公差): <6° ± 10' <30° ± 20' <120° ± 30' >120° ± 1°	Part Name (零/部件名称):	后面板		Drawing Number (图号):
	Drawn by (绘图): 莫永康	Date (日期): 2020.05.16	Size: (图幅):	A4
	Check by (校对):	Date (日期):	Scale (比例):	1:1
	Signature by (批准):	Date (日期):	Revision (版本):	A1
				Sheet (页数):
				1 / 1