

7	GB-T-819.1-2000-C-NI-M3X6	碳钢镀镍十字沉头螺丝M3X6	普通碳钢	20	0.0004	
6	GB-T-819.1-2000-C-NI-M3X8	碳钢镀镍十字沉头螺丝M3X8	普通碳钢	4	0.0005	
5	YG-C07B-0000-002	后面板	6063-T5	1	0.291	
4	YG-TY-JM-001	角码30X30X1.5	普通碳钢	4	0.005	
3	YG-C07B-0000-003	盖板	5052-H32	2	0.659	
2	YG-C07B-0000-004	侧板	6063-T5	2	0.182	
1	YG-C07B-0000-001	前面板	6063-T5	1	0.317	
序号	图号	名称	材料	数量	单重	备注

#### 技术要求:

- 1、必须按照设计、工艺要求及本规定和有关标准进行装配;
- 2、所有零部件(包括外购、外协件)必须具有检验合格证方能进行装配;
- 3、零件在装配前必须清理和清洗干净,不得有毛刺、飞边、氧化皮、锈蚀、切屑、砂粒、灰尘和油污等,并应符合相应清洁度要求;
- 4、装配过程中零件不得磕碰、划伤和锈蚀;
- 5、油漆未干的零件不得进行装配;
- 6、相对运动的零件,装配时接触面间应加润滑油;
- 7、各零、部件装配后相对位置应准确。

Break sharp edges (未注锐边倒角): Ch 0.05 to 0.25 x45°	Angular tolerances (未注角度公差): <6° ± 10' <30° ± 20' <120° ± 30' >120° ± 1°
Position tolerances (未注位置公差): ± 0.05	

Tolerances (未注公差): 0.5 to 6 ± 0.1 6 to 30 ± 0.2 30 to 120 ± 0.3 120 to 400 ± 0.4	Material (材料): (装配图)	<b>YONGU</b> 永固	Drawing Number (图号): YG-C07B-0000-000
Weight: (重量) (Kg): 2.319	Protection: (表面处理):		
Part Name (零/部件名称): C07B机箱	Drawn by (绘图): 邓展锋		
	Date (日期): 2020.05.25	Size (图幅): A0	Sheet (页数):
	Check by (校对):	Scale (比例): 1:1.2	Revision (版本): A1
	Signature by (批准):	Date (日期):	1 / 1

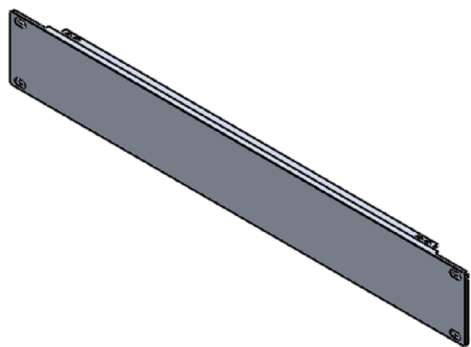
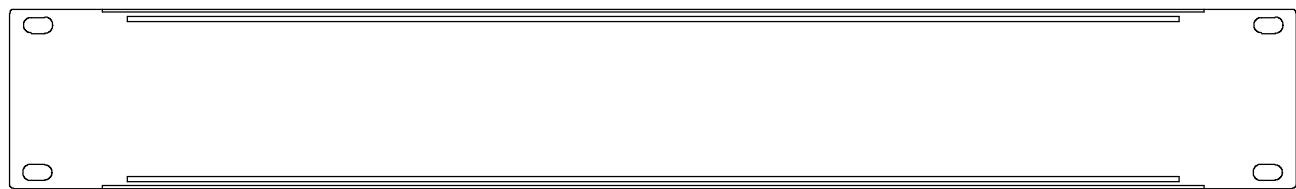
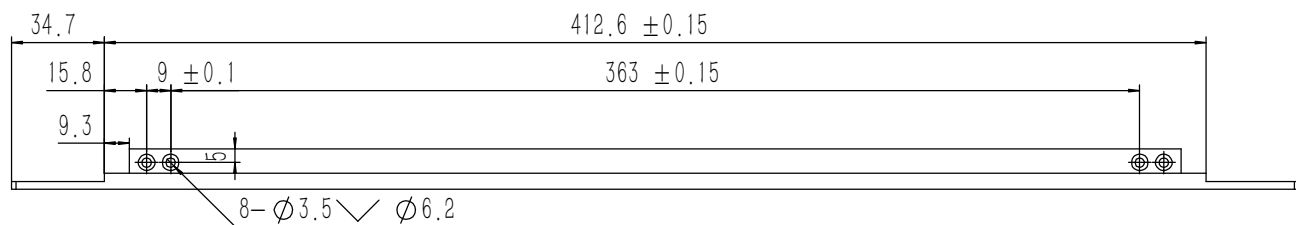
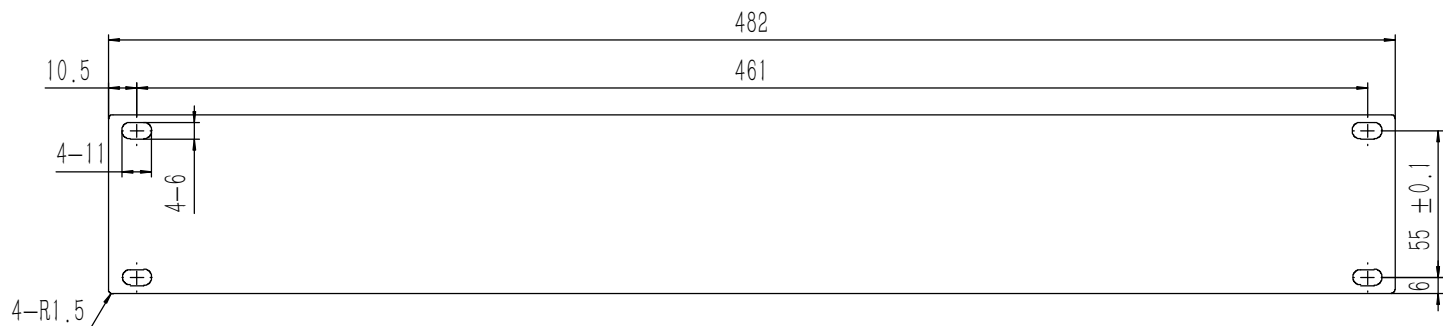
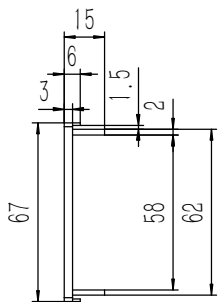

技术要求:

- 1、零件加工表面不应有划痕、擦伤等损伤零件表面的缺陷;
- 2、去除毛刺飞边, 锐角倒钝;
- 3、未标注尺寸见3D数模。

Tolerances (未注公差): 0.5 to 6 ± 0.1 6 to 30 ± 0.2 30 to 120 ± 0.3 120 to 400 ± 0.4	Material (材料):	6063-T5	<b>YONGU</b> 永固
	Weight: (重量) (Kg):	0.317	
Break sharp edges (未注锐边倒角): Ch 0.05 to 0.25 x45°	Protection: (表面处理):		Drawing Number (图号): YG-C07B-0000-001
	Position tolerances (未注位置公差): ± 0.05	Part Name (零/部件名称): 前面板	
Angular tolerances (未注角度公差): <6° ± 10' <30° ± 20' <120° ± 30' >120° ± 1°	Drawn by (绘图): 邓展锋	Date (日期): 2020.05.25	Size: (图幅): A1
	Signature by (批准):	Date (日期):	Scale (比例): 1:1
		Date (日期):	Revision (版本): A1
			Sheet (页数): 1 / 1

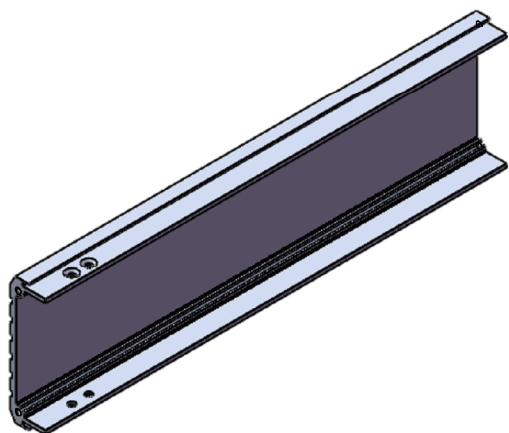
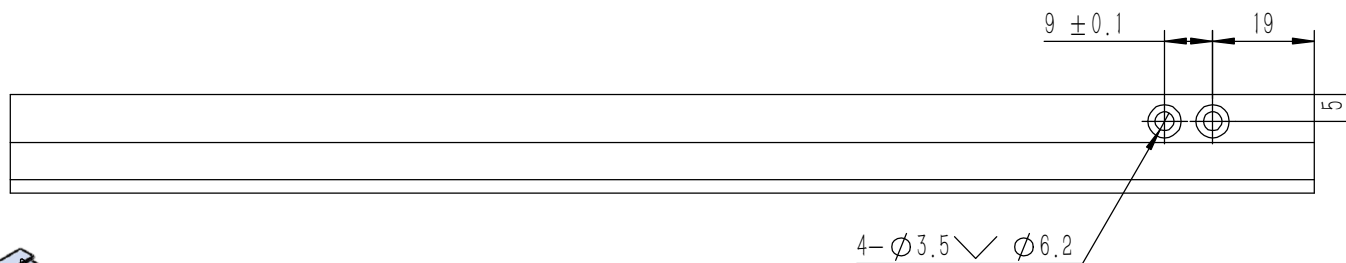
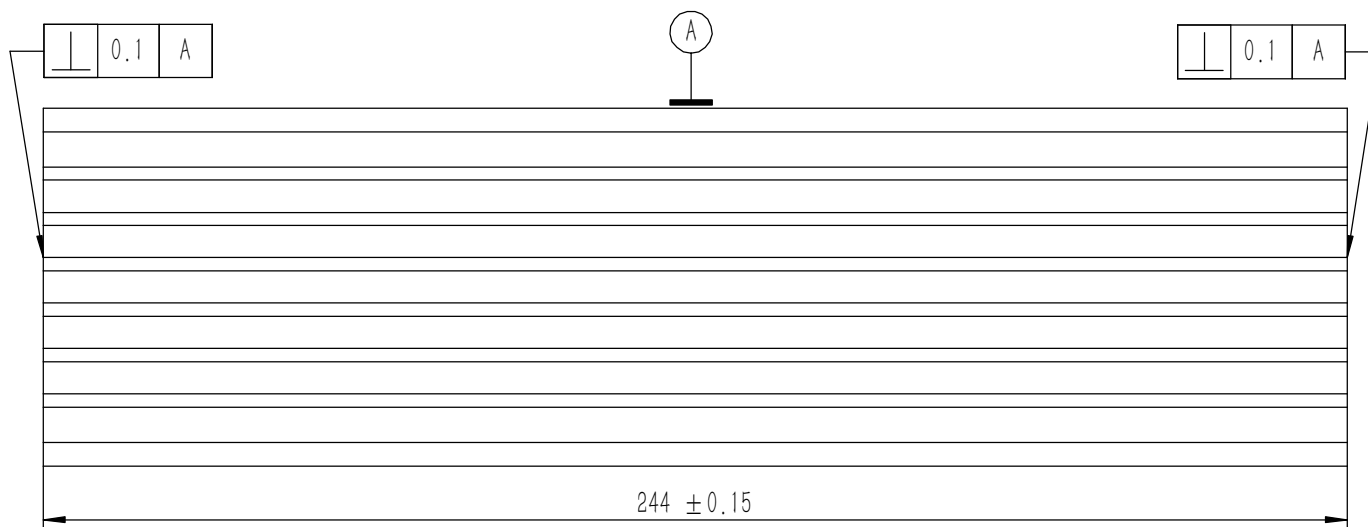
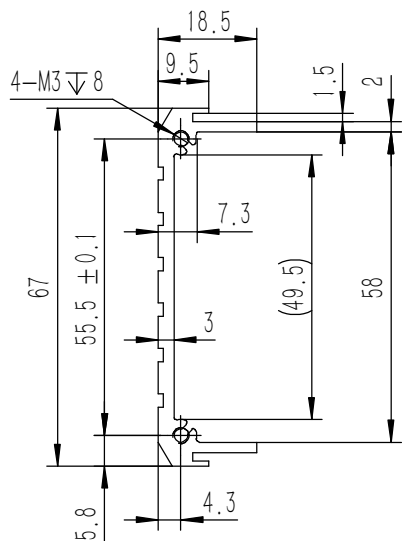

技术要求:

- 1、零件加工表面不应有划痕、擦伤等损伤零件表面的缺陷;
- 2、去除毛刺飞边,锐角倒钝;
- 3、未标注尺寸见3D数模。

Tolerances (未注公差): 0.5 to 6 ± 0.1 6 to 30 ± 0.2 30 to 120 ± 0.3 120 to 400 ± 0.4	Material (材料):	6063-T5	<b>YONGU</b> 永固
	Weight: (重量) (Kg)	0.182	
Break sharp edges (未注锐边倒角): Ch 0.05 to 0.25 x45°	Protection: (表面处理):		Drawing Number (图号): YG-C07B-0000-004
	Position tolerances (未注位置公差): ±0.05	Part Name (零/部件名称): 侧板	
Angular tolerances (未注角度公差): <6° ± 10' <30° ± 20' <120° ± 30' >120° ± 1°	Part Name (零/部件名称):	侧板	Size: (图幅): A3
	Drawn by (绘图): 邓展锋	Date (日期): 2020.05.25	Scale (比例): 1:1
	Check by (校对):	Date (日期):	Revision (版本): A1
	Signature by (批准):	Date (日期):	Sheet (页数): 1 / 1



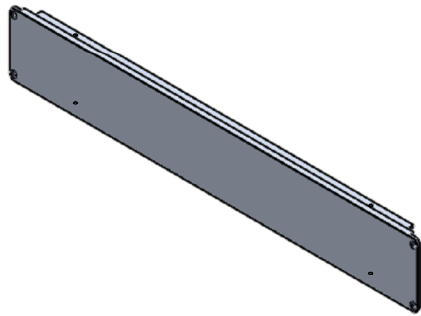
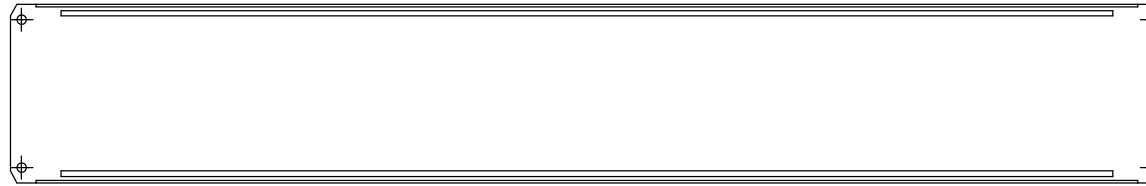
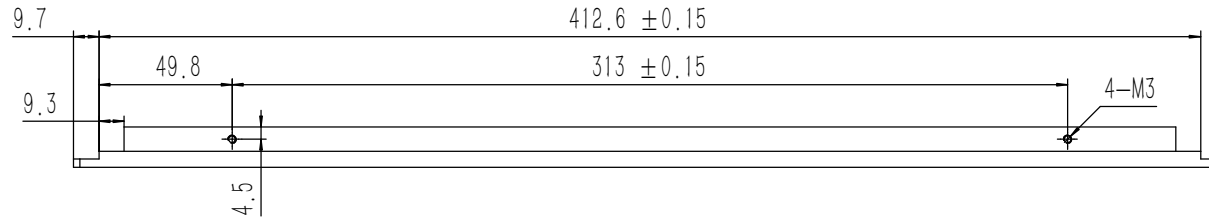
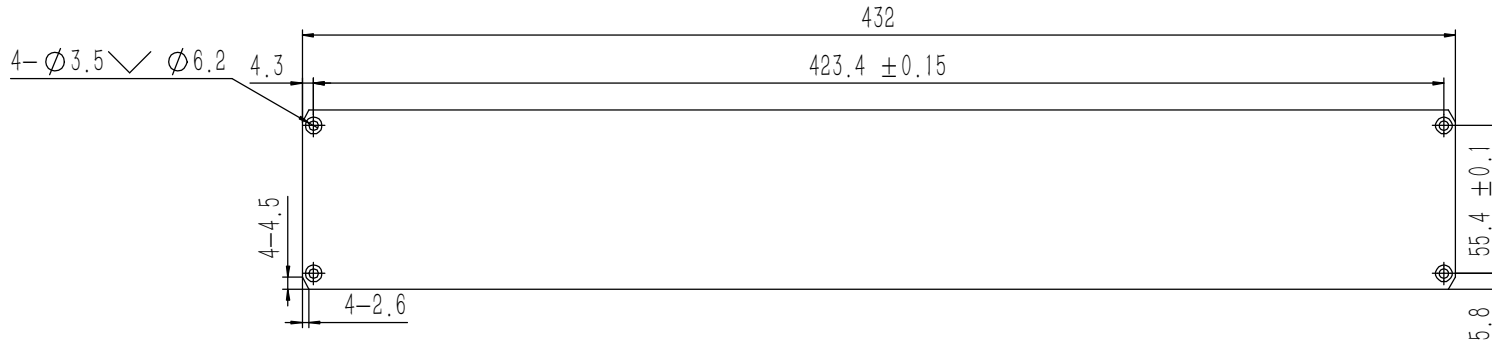
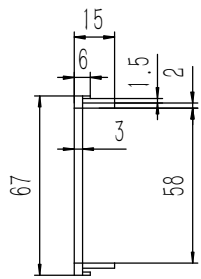

技术要求:

- 1、零件加工表面不应有划痕、擦伤等损伤零件表面的缺陷;
- 2、去除毛刺飞边,锐角倒钝;
- 3、未标注尺寸见3D数模。

Tolerances (未注公差):	
0.5 to 6	± 0.1
6 to 30	± 0.2
30 to 120	± 0.3
120 to 400	± 0.4

Material (材料):	6063-T5
Weight: (重量) (Kg):	0.291
Protection: (表面处理):	
Part Name (零/部件名称):	后面板

**YONGU** 永固

Break sharp edges (未注锐边倒角): Ch 0.05 to 0.25 x45°	Angular tolerances (未注角度公差):
	<6° ± 10'
	<30° ± 20'
	<120° ± 30'
	>120° ± 1°

Position tolerances (未注位置公差):	± 0.05
----------------------------------	--------

Drawn by (绘图): 邓展锋	Date (日期): 2020.05.25
Check by (校对):	Date (日期):
Signature by (批准):	Date (日期):

Size: (图幅): A1	Scale (比例): 1:1
Revision (版本): A1	

Drawing Number (图号):	YG-C07B-0000-002
Sheet (页数):	1 / 1