

技术要求:

- 1、必须按照设计、工艺要求及本规定和有关标准进行装配;
- 2、所有零部件(包括外购、外协件)必须具有检验合格证方能进行装配;
- 3、零件在装配前必须清理和清洗干净,不得有毛刺、飞边、氧化皮、锈蚀、切屑、砂粒、灰尘和油污等,并应符合相应清洁度要求;
- 4、装配过程中零件不得磕碰、划伤和锈蚀;
- 5、油漆未干的零件不得进行装配;
- 6、相对运动的零件,装配时接触面间应加润滑油脂;
- 7、各零、部件装配后相对位置应准确。

8	GB-T-70.1-2000-C-BE-M3X8	碳钢发黑内六角杯头螺丝M3X8	普通碳钢	16	0.001	
7	YG-S-2-06	黑色大包角	黑色 TPE 90A	8	0.032	
6	GB-T-39-1988-C-ZI-M3	方螺母镀锌M3	普通碳钢	8	0.0004	
5	GB-T-70.3-2000-C-NB-M3X6	芳生镀黑镍内六角沉头螺丝M3X6	普通碳钢	8	0.0004	
4	YG-TY-LMT-002	塑料螺母套 M3	ABS	8	0.0001	
3	YG-S201-0000-003	挡板	5052-H32	2	0.103	
2	YG-S201-0000-002	上下盖板	5052-H32	2	0.530	
1	YG-S201-0000-001	连接条	6063-T5	2	0.037	
序号 (Item)	图号 (Drawing Number)	名称 (Part Name)	材料 (Material)	数量 (QTY)	单重 (Weight)	备注 (Note)

Tolerances (未注公差):		Material (材料): (装配图)		YONGU 永固	
0.5 to 6 ± 0.1	6 to 30 ± 0.2	Weight: (重量) (Kg):	1.618		
30 to 120 ± 0.3	120 to 400 ± 0.4	Protection: (表面处理):		Drawing Number (图号):	
Break sharp edges (未注锐边倒角): Ch 0.05 to 0.25 x45°		Part Name (零/部件名称):		YG-S201-0000-000	
Angular tolerances (未注角度公差):		S201大包角机箱		Date (日期): 2021.06.03	
<6° ± 10'	<30° ± 20'	Drawn by (绘图): 江瑞章		Size (图幅): A0	
<120° ± 30'	>120° ± 1°	Check by (校对):		Scale (比例): 1:1	
Position tolerances (未注位置公差): ±0.05		Signature by (批准):		Date (日期):	
				Revision (版本): A1	
				Sheet (页数): 1 / 1	

业务代码: 150-180

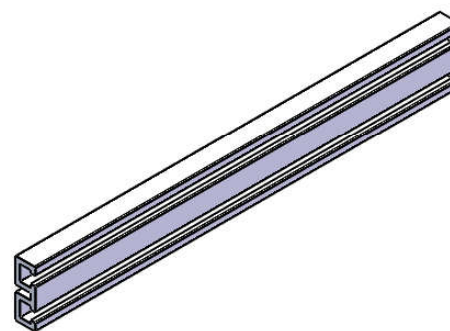
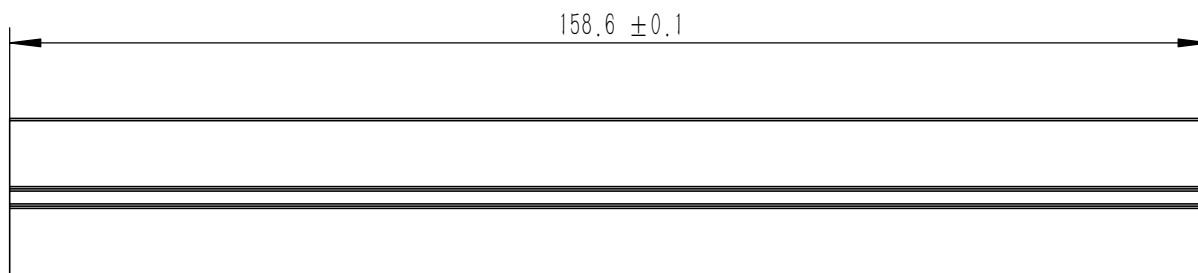
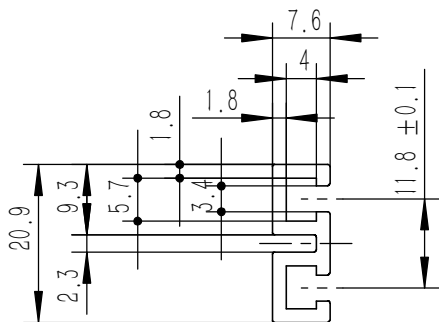

技术要求:

- 1、未注倒角R0.3, 未标锐边的倒角不超R0.1
- 2、零件加工表面不应有划痕、擦伤等损伤零件表面的缺陷;
- 3、未标注尺寸见电子档图纸

业务代码: 150-180

Tolerances (未注公差): 0.5 to 6 ± 0.1 6 to 30 ± 0.2 30 to 120 ± 0.3 120 to 400 ± 0.4	Material (材料):	6063-T5		YONGU 永固
	Weight: (重量) (Kg)	0.037		
Break sharp edges (未注锐边倒角): Ch 0.05 to 0.25 x45°	Protection: (表面处理):			
	Position tolerances (未注位置公差): ±0.05	Part Name (零/部件名称):	连接条	
Angular tolerances (未注角度公差): <6° ± 10' <30° ± 20' <120° ± 30' >120° ± 1°	Drawn by (绘图):	江瑞章	Date (日期):	2021.06.03
	Signature by (批准):		Date (日期):	
		Drawing Number (图号):		YG-S201-0000-001
		Scale (比例):	1:1	Sheet (页数):
		Revision (版本):	A1	1 / 1

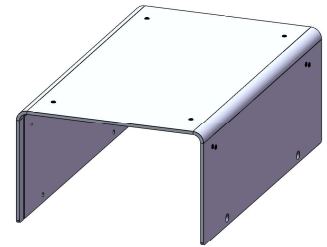
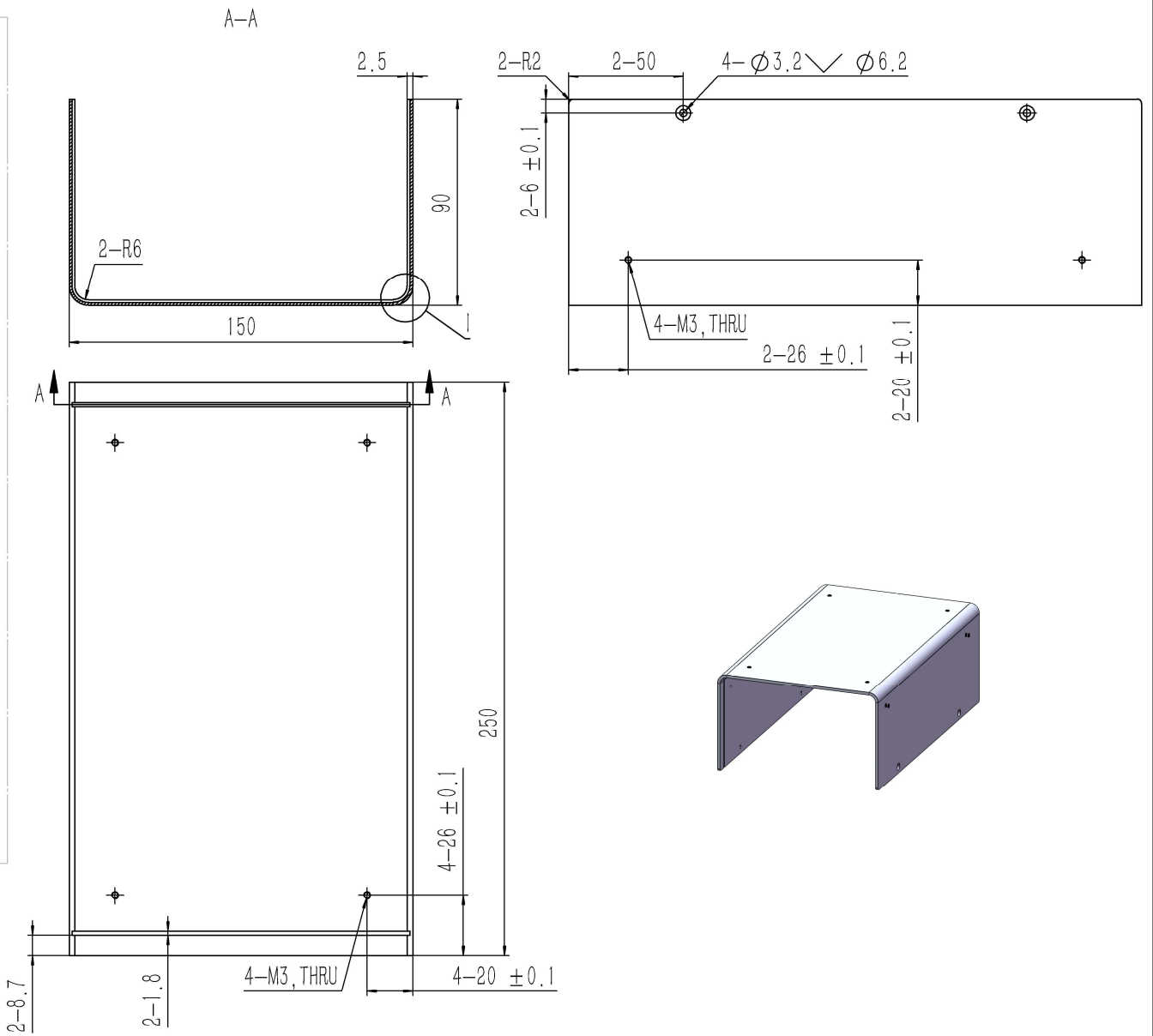
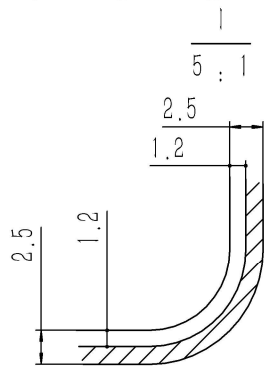
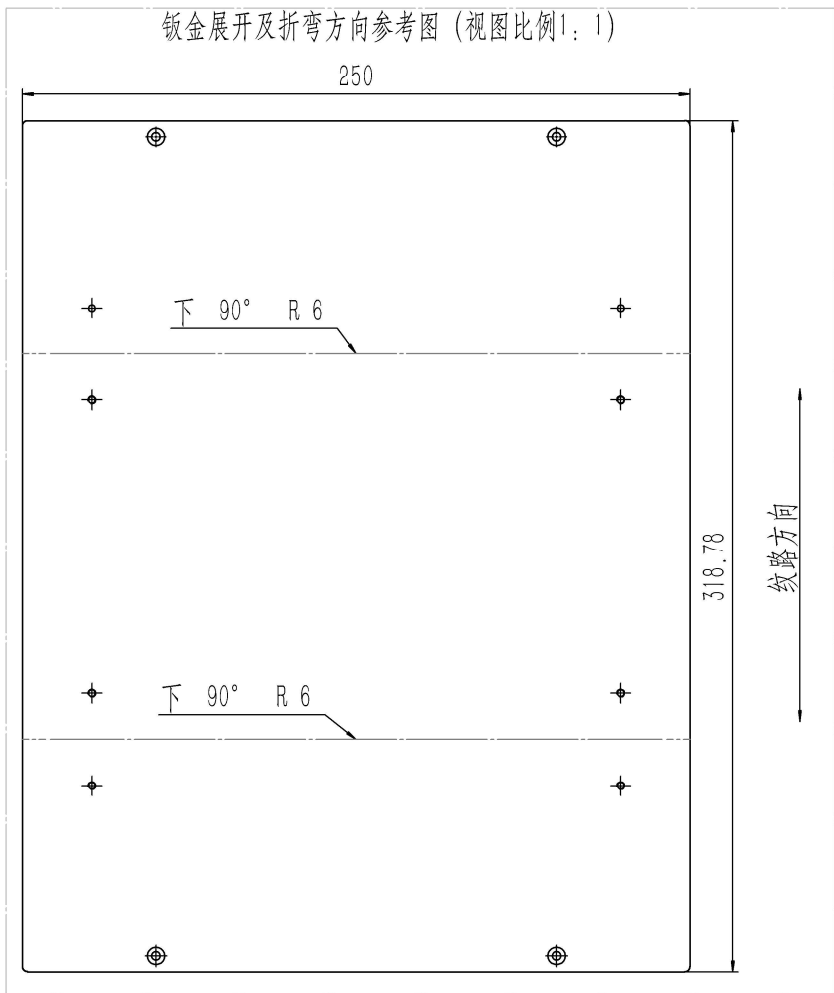

- 技术要求:
- 1、零件加工表面不应有划痕、擦伤等损伤零件表面的缺陷;
 - 2、去除毛刺飞边,锐角倒钝;
 - 3、未标注尺寸见3D数模。

业务代码: 150-180

Tolerances (未注公差): 0.5 to 6 ± 0.1 6 to 30 ± 0.2 30 to 120 ± 0.3 120 to 400 ± 0.4	Material (材料):	5052-H32	YONGU 永固
	Weight: (重量) (Kg):	0.530	
Break sharp edges (未注锐边倒角): Ch 0.05 to 0.25 x45°	Protection: (表面处理):		Drawing Number (图号): YG-S201-0000-002
	Angular tolerances (未注角度公差):	Part Name (零/部件名称):	
Position tolerances (未注位置公差): ±0.05	<6° ± 10' <30° ± 20' <120° ± 30' >120° ± 1°	Drawn by (绘图): 江瑞章 Date (日期): 2021.06.03	Size: (图幅): A1 Sheet (页数): 1 / 1
		Check by (校对): Date (日期):	Scale (比例): 1:1
		Signature by (批准): Date (日期):	Revision (版本): A1

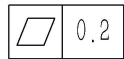
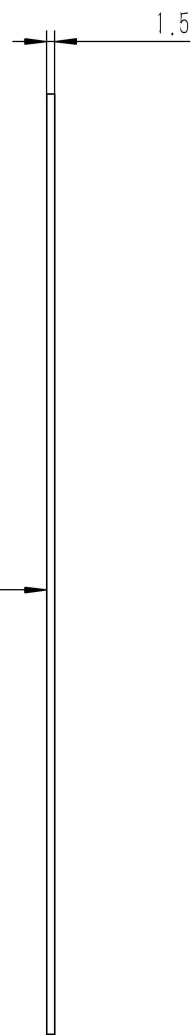
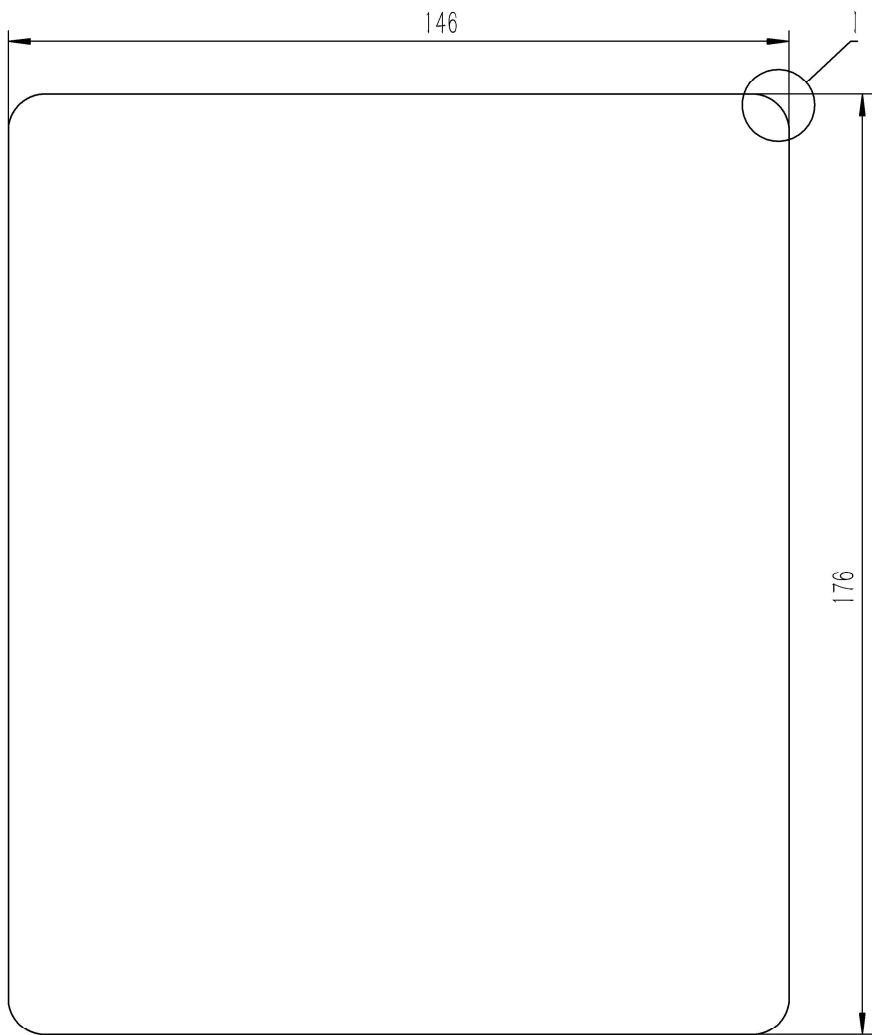

纹路方向

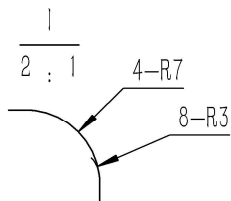

技术要求:

- 1、零件加工表面不应有划痕、擦伤等损伤零件表面的缺陷;
- 2、去除毛刺飞边,锐角倒钝;
- 3、未标注尺寸见3D数模。

业务代码: 150-180

Break sharp edges (未注锐边倒角): Ch 0.05 to 0.25 x45°	Angular tolerances (未注角度公差): <6° ± 10' <30° ± 20' <120° ± 30' >120° ± 1°
Position tolerances (未注位置公差): ±0.05	

Tolerances (未注公差): 0.5 to 6 ± 0.1 6 to 30 ± 0.2 30 to 120 ± 0.3 120 to 400 ± 0.4	Material (材料): 5052-H32	YONGU 永固
	Weight: (重量) (Kg) 0.103	
Protection: (表面处理):	Part Name (零/部件名称): 挡板	Drawing Number (图号): YG-S201-0000-003
Drawn by (绘图): 江瑞章	Date (日期): 2021.06.03	Size (图幅): A3
Check by (校对):	Date (日期):	Scale (比例): 1:1
Signature by (批准):	Date (日期):	Revision (版本): A1

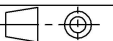

Sheet (页数):

1 / 1