

**KITO**  
Beyond Your Imagination



**KITO**  
**2CM**  
AN OUTDOOR FAVORITE



GUANGDONG KITO CERAMICS GROUP CO.,LTD.  
Building T6, Smart City Jihua 1st Road, Chancheng Dist., Foshan Guangdong 528000, China  
Tel: +86 757 82533869 | Fax: +86 757 82533866 | Email: [thankyou@kito.cn](mailto:thankyou@kito.cn)

[www.kito.cn](http://www.kito.cn)  
[www.kitoceramics.com](http://www.kitoceramics.com)

**KITO**  
Beyond Your Imagination



01~02  
ABOUT THE BRAND

05~16  
9 APPLICATIONS

17~18  
PROJECT CASES

# INDEX

19~26  
COLLECTIONS

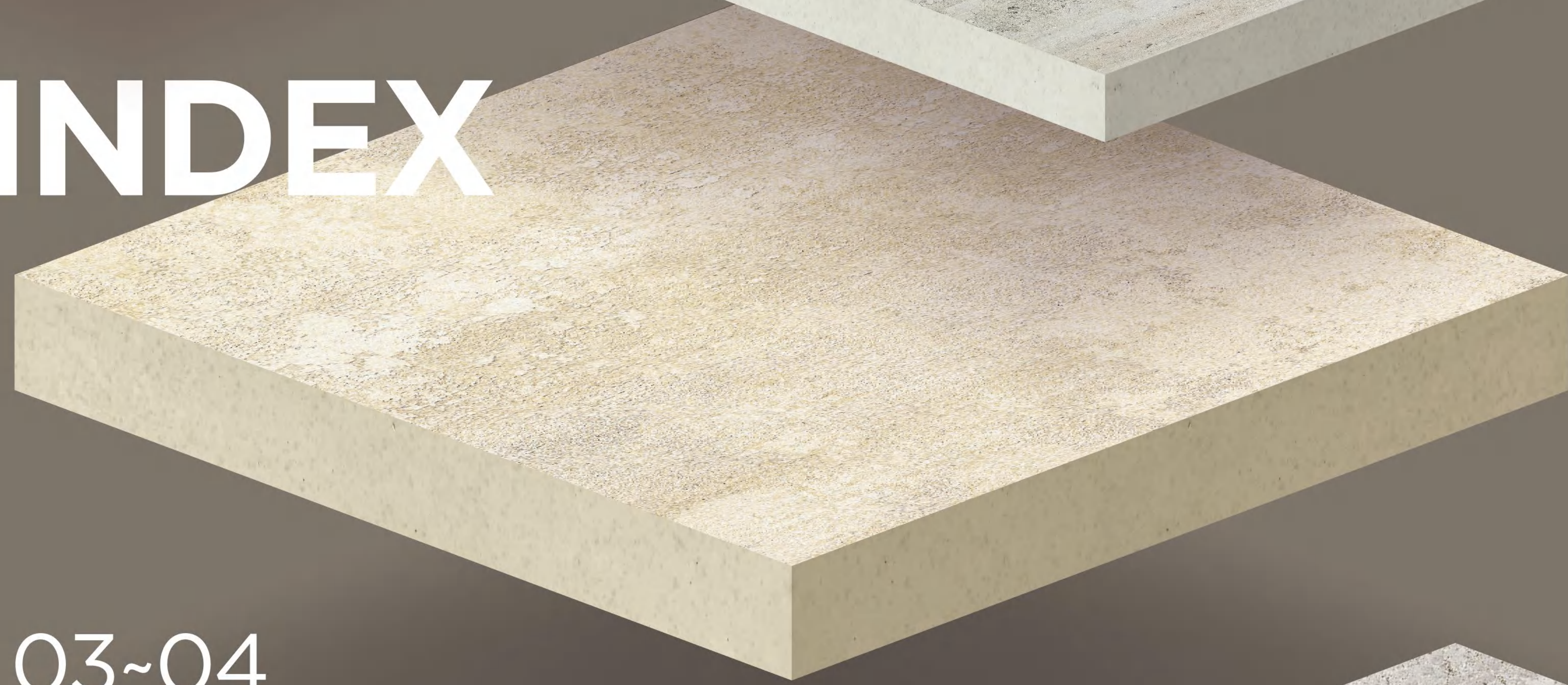

27  
PARAMETER INFO



28  
ACCESSORIES

29  
PACKING INFO

03~04  
OUR DIFFERENTIATION &  
4 KEY METHODS OF APPLICATION



# Why KITO BEYOND YOUR IMAGINATION

## LEADING GLAZED TILE MANUFACTURER

KITO is a specialized porcelain tile manufacturer in Foshan, China, with 20 years of experience in producing top-grade glazed porcelain-tiles. The annual output is more than 20 million M2.

## POWERFUL R&D TEAM SUPPORT

More than 300 engineers and experts including Italian designers 288 cases awarded the national patents.

## RICH PRODUCT RANGE

Size: from 600x300mm to 1600x3200mm  
Thickness: 6 mm to 20mm  
Surface: full polished, honed, lappato, matte, sugar effect, stone touch surface and rough  
Techniques: ink-jet printing

## TQC SYSTEM

In accordance with EN14411:2016 standard.



2018 China 500 Most Valuable Brands



SGS is recognized as the global benchmark for quality and integrity



In Accordance With EN14411:2016 Standard



A recognized world leader in testing inspection and certification services (TIC)



Three Star Certification Of Green Building Materials



UK Conformity Assessment

# OUR DIFFERENTIATION

# 4 KEY METHODS OF APPLICATION

EASY TO INSTALL AND MAINTAIN

**Anti-slip R11**  
KITO 2CM outdoor porcelain tiles reach R11 which provides traction close to that of natural stone. R12 also available for customization.

**High Breaking Strength**  
KITO 2CM outdoor porcelain tiles reach a breaking strength of 10,200N. Similar natural stone would be 4cm thick to have the same breaking strength.

**2CM**

**Full Body**  
Advanced technologies such as full body tiling, in addition to high pressure and high temperature treatment, are adopted in the manufacturing process. As a result, 2CM outdoor porcelain tiles has high breaking strength, low water absorption ( $\leq 0.5\%$ ) and class 3 abrasion resistance.

**Natural Stone Texture**  
KITO 2CM outdoor porcelain tiles are full 20mm in thickness, which provides an elegant natural stone texture.

*Laid on gravel*



*Laid on grass*

*Laid on mortar*

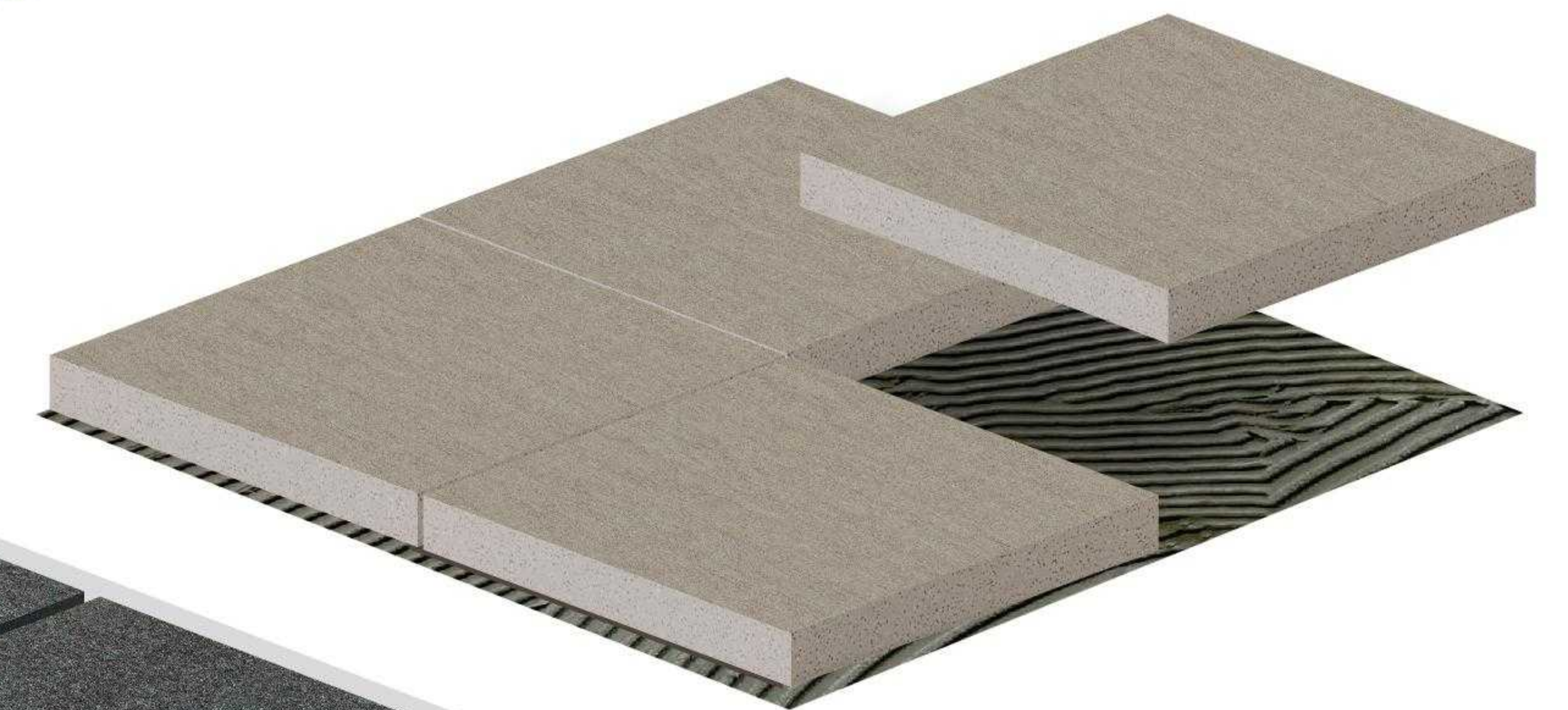

*Laid on pedestal*

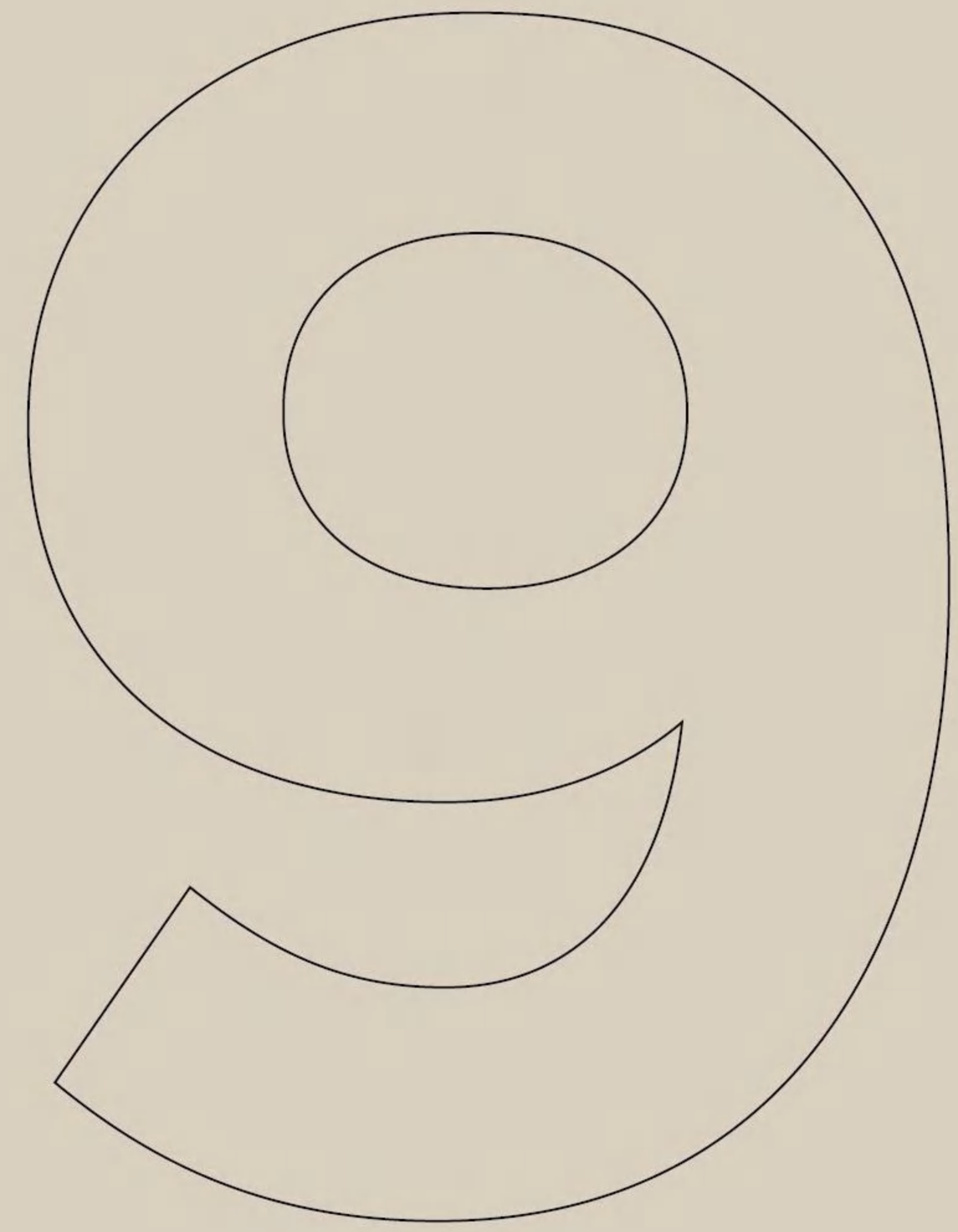

# 9 APPLICATIONS

KITO 2CM tiles are suitable for various outdoor locations, including swimming pool, balconies and so on.

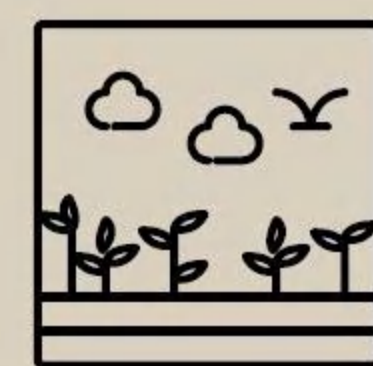

ON GRASS



ON GRAVEL

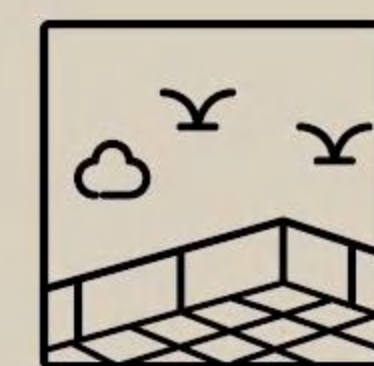

FRONT & BACK YARD



GARDEN

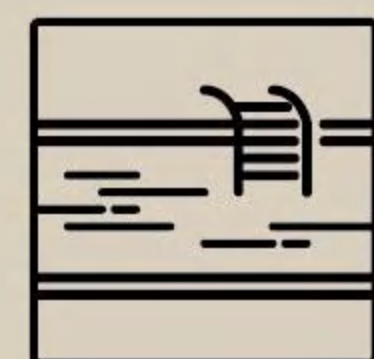

SWIMMING POOL



TRAFFIC SITE

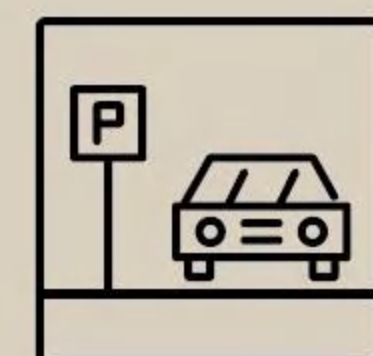

GARAGE & PARKING

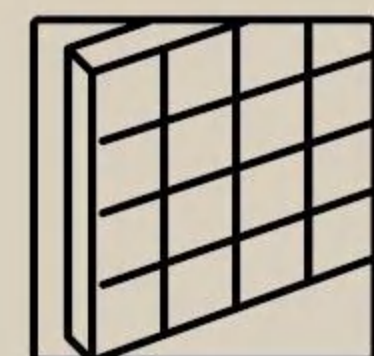

EXTERNAL FACADES

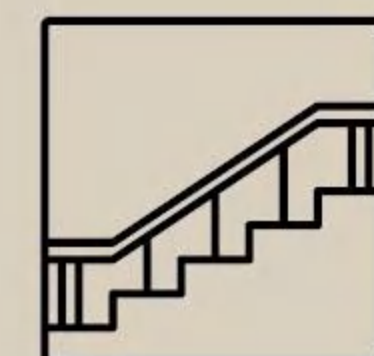

STAIRCASE STEPS



# ON GRASS

The 2CM porcelain tile can be easily positioned on grass, removed and repositioned, allowing maximum flexibility in creating different configurations.

Easy to install and remove;

Quick water drainage keeping the ground unchanged;

Ideal to create continuity between indoor and outdoor flooring.

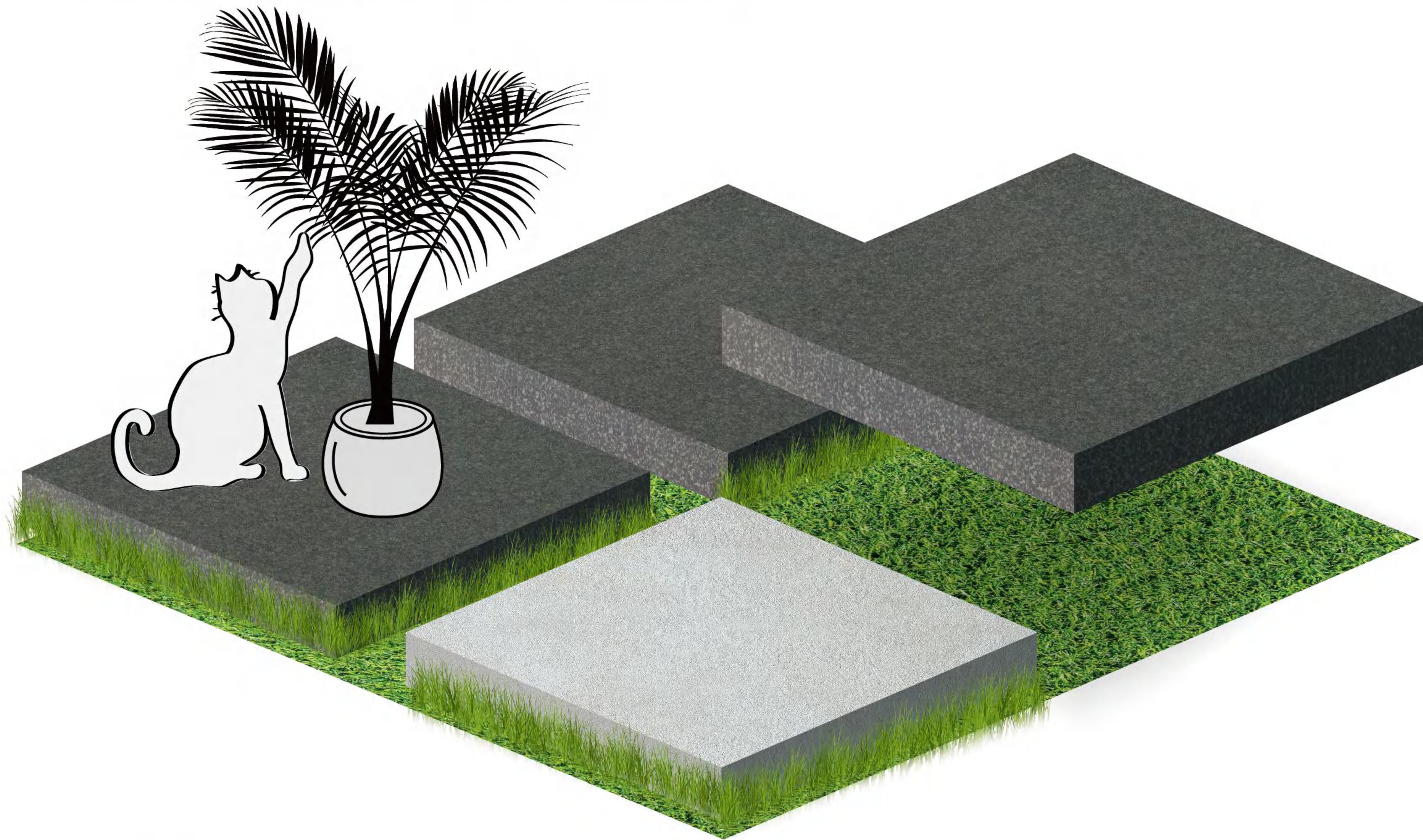

## Basalt Stone

K0606529DAZ  
600×600×20mm

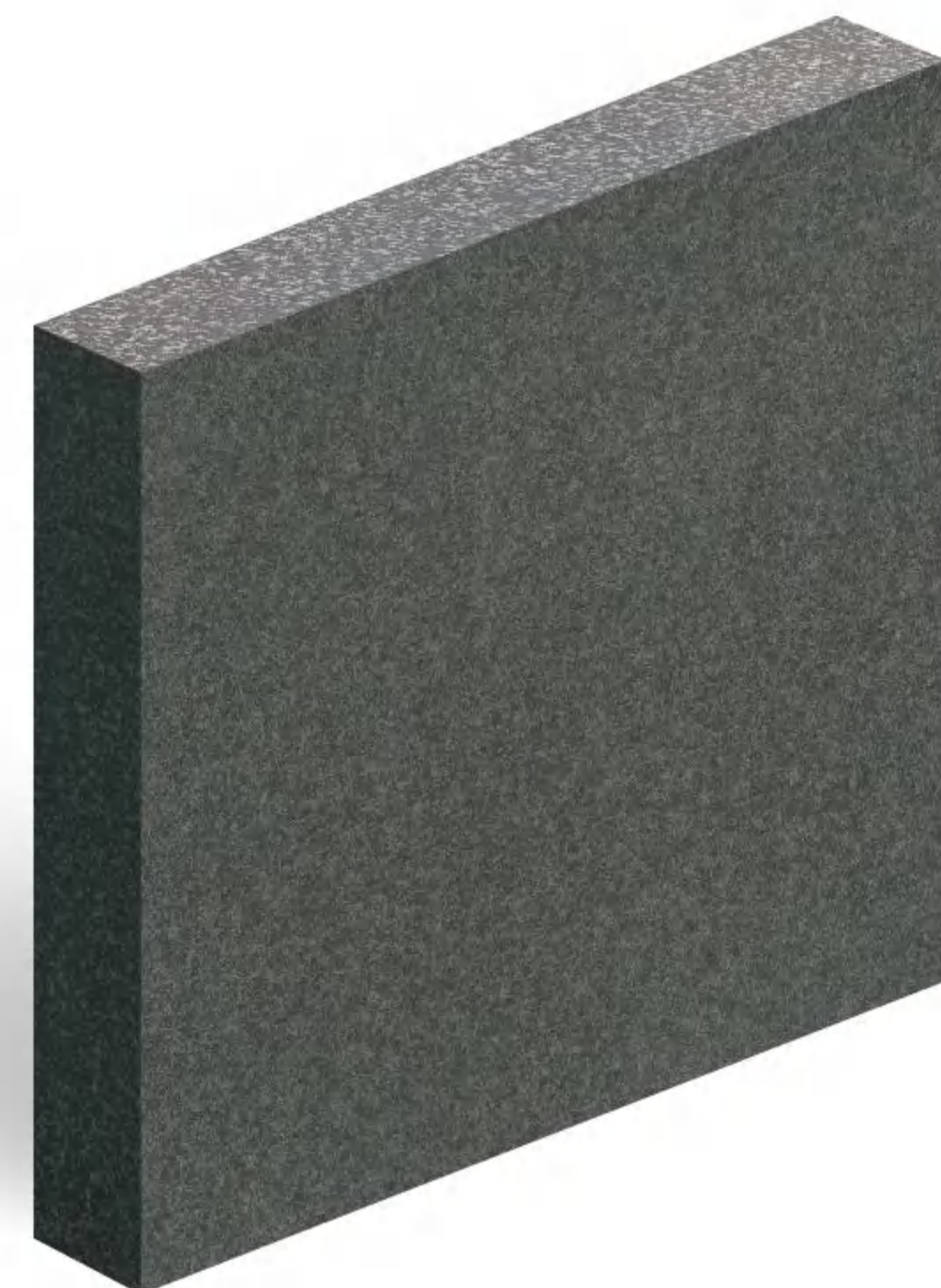

## Ales

K0603525DAZ  
600×600×20mm

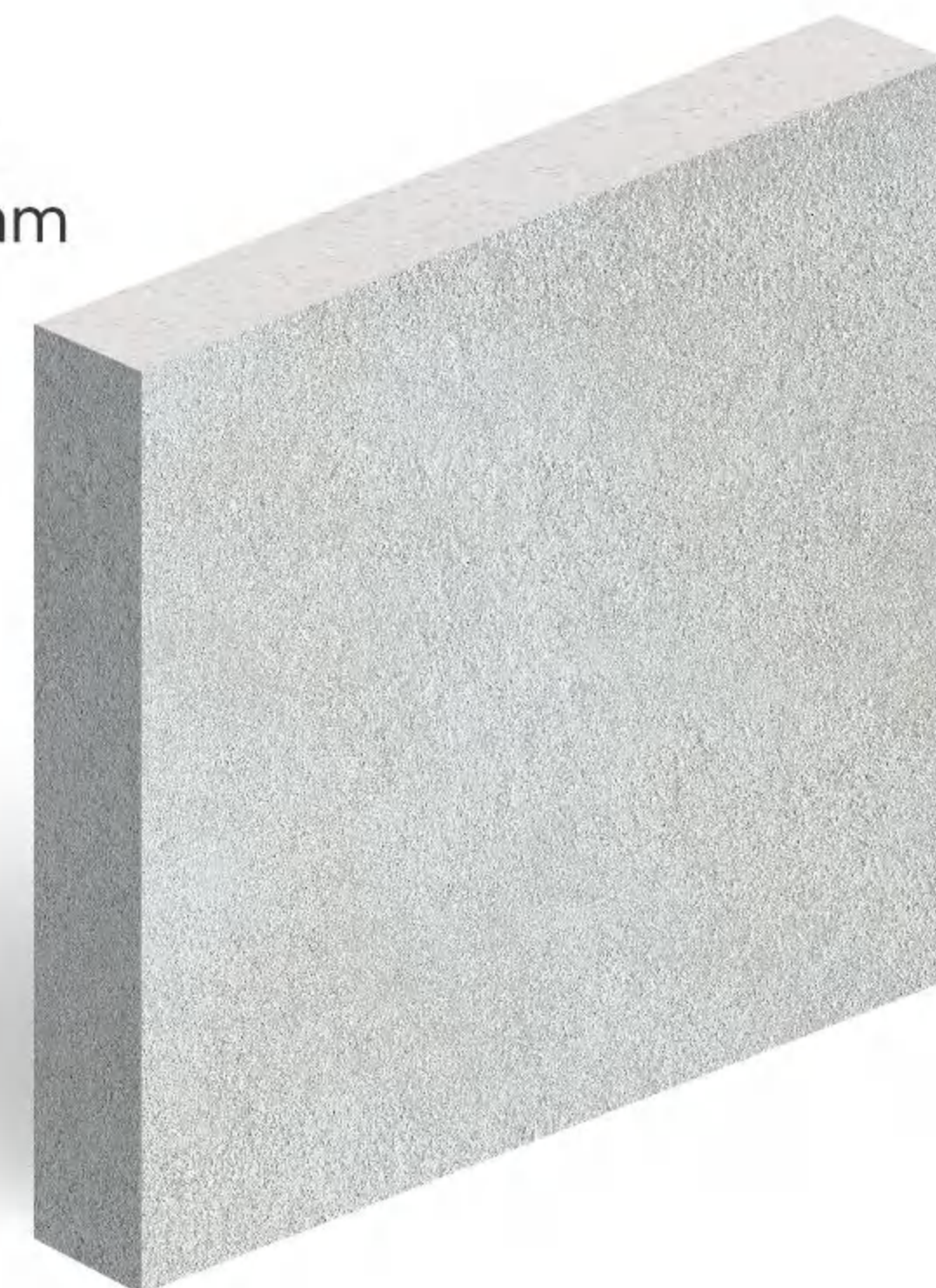

# ON GRAVEL



## Ales

K0603517DAZ  
600×600×20mm



# FRONT YARD



**Ivory Wood**  
K00606979ZAO  
600×600×20mm



**Sterling**  
K00606100ZAO  
600×600×20mm

# BACK YARD

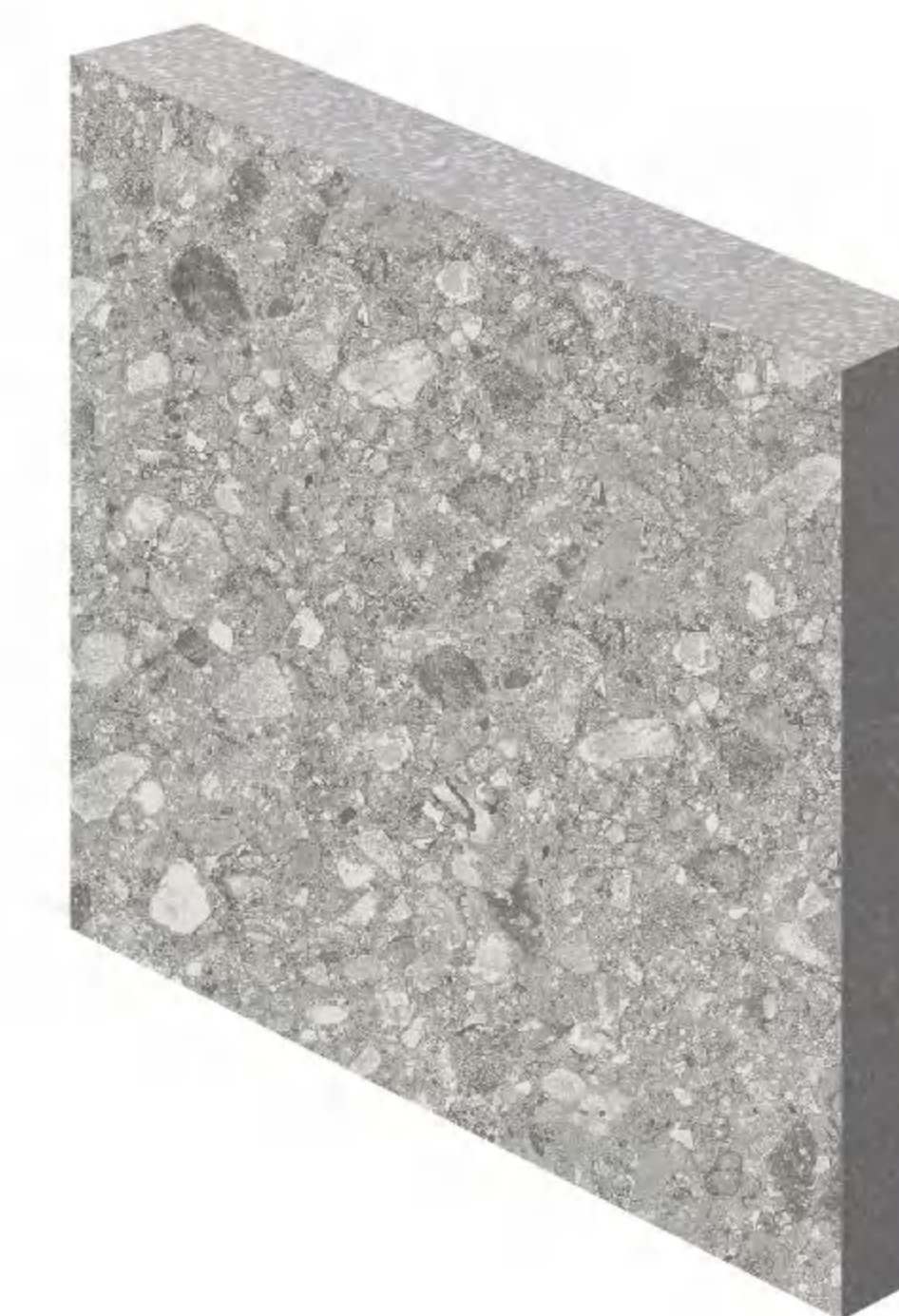

**Terrazzo**  
K00606977ZAO  
600×600×20mm

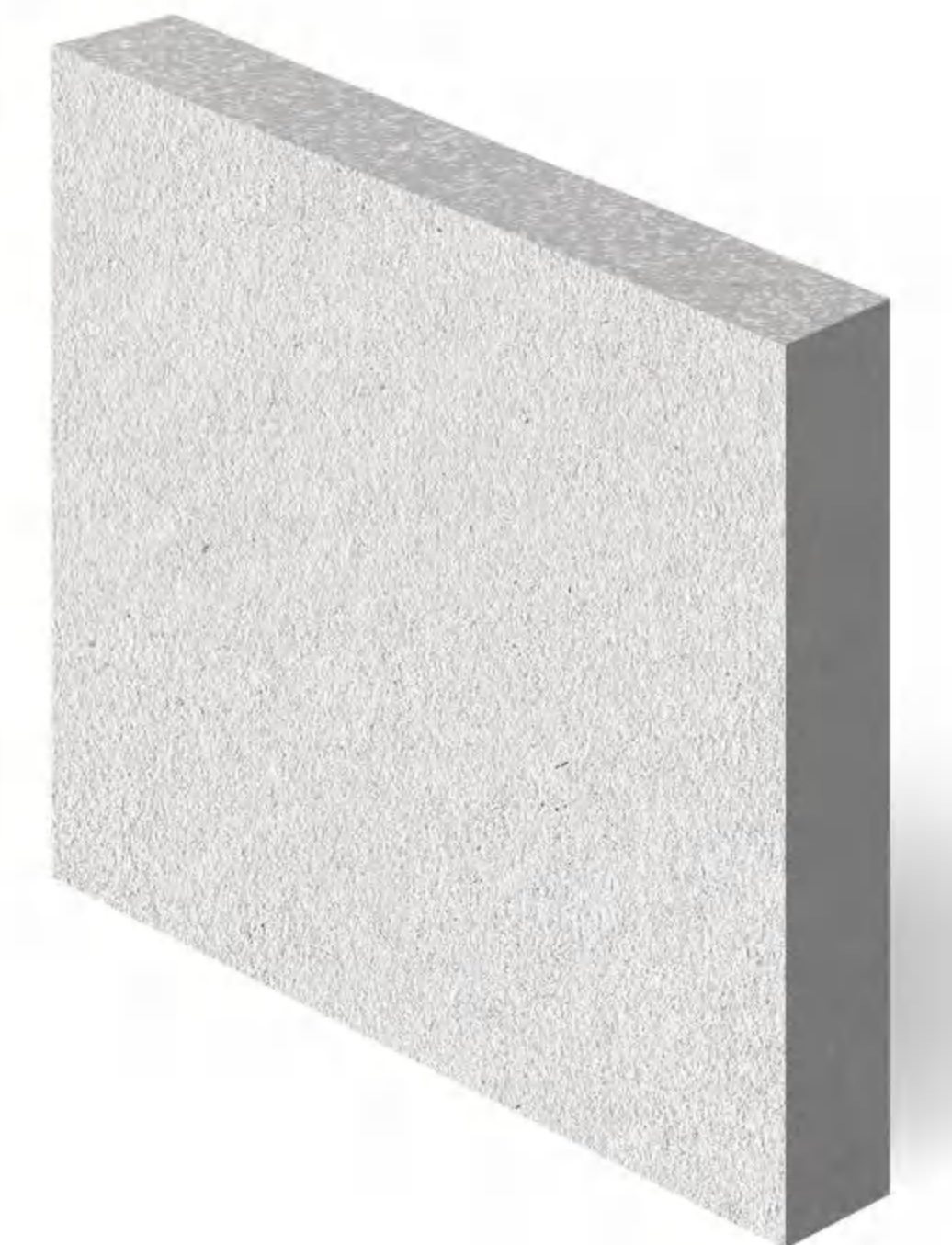

**Trani**  
K00608036ZAO  
600×600×20mm



# GARDEN



**Sterling**  
K00606098ZAO  
600×600×20mm

# SWIMMING POOL

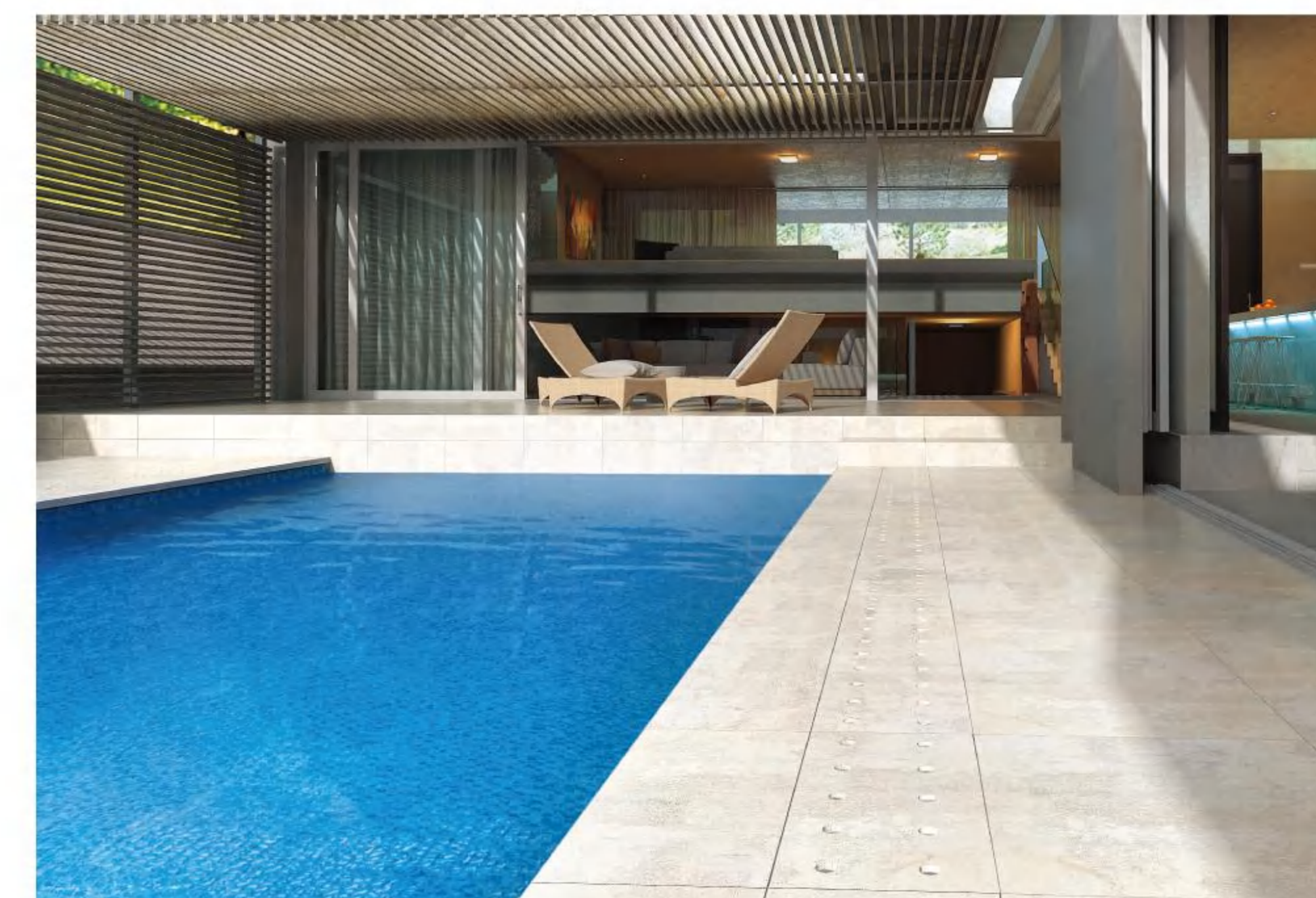

**Cement**  
K0603704DAZ  
600×600×20mm



# TRAFFIC SITE



**Ales**  
K0603525DAZ  
600×600×20mm

# GARAGE & PARKING

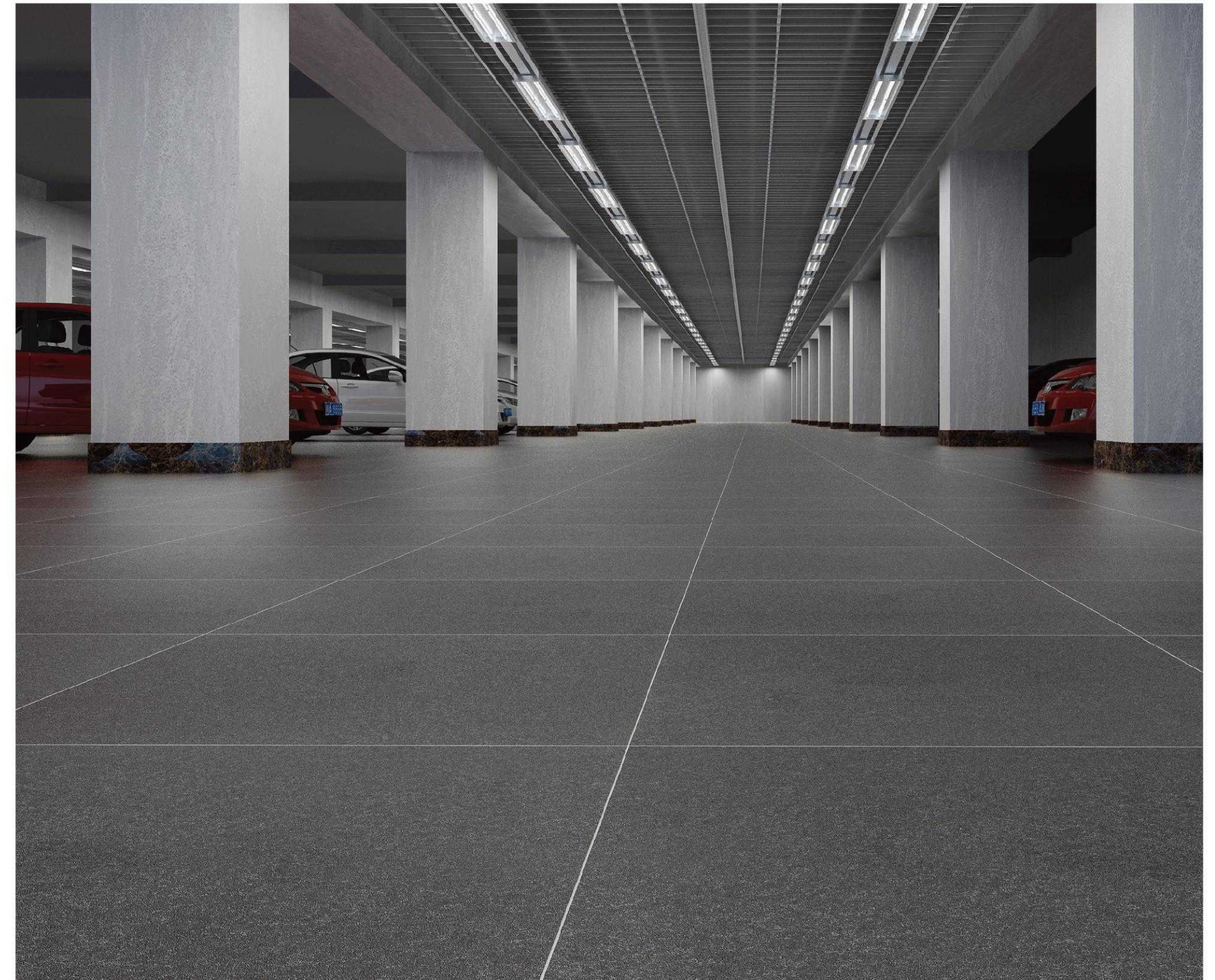

**Basalt Stone**  
K0606033DAZ  
600×600×20mm

# EXTERNAL FACADES

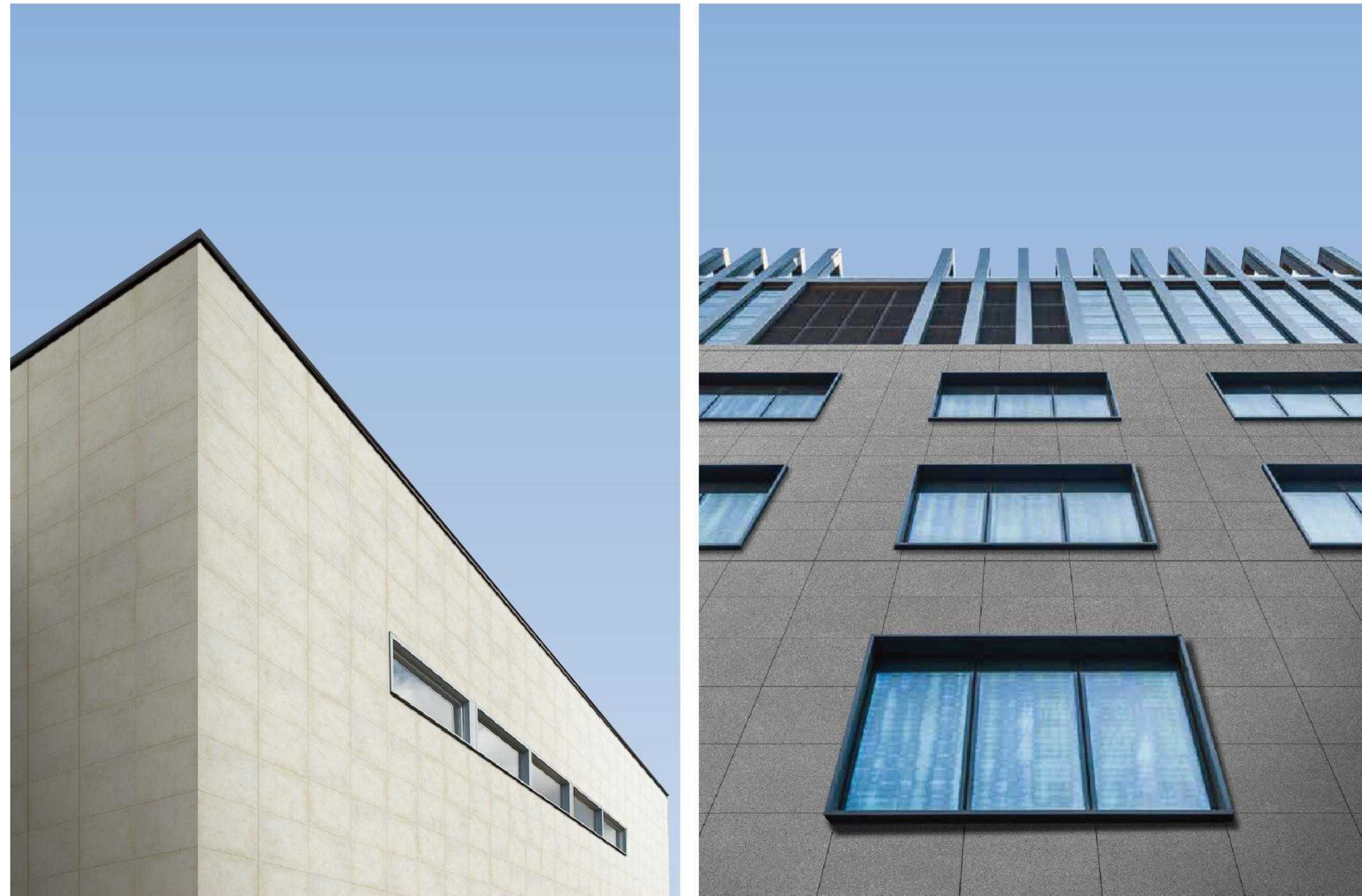

## Ales

K0603525DAZ  
600×600×20mm



## Basalt Stone

K0606503DAZ  
600×600×20mm

# STAIRCASE STEPS



## Cement

K0603704DAZ  
600×600×20mm  
1200×600×20mm

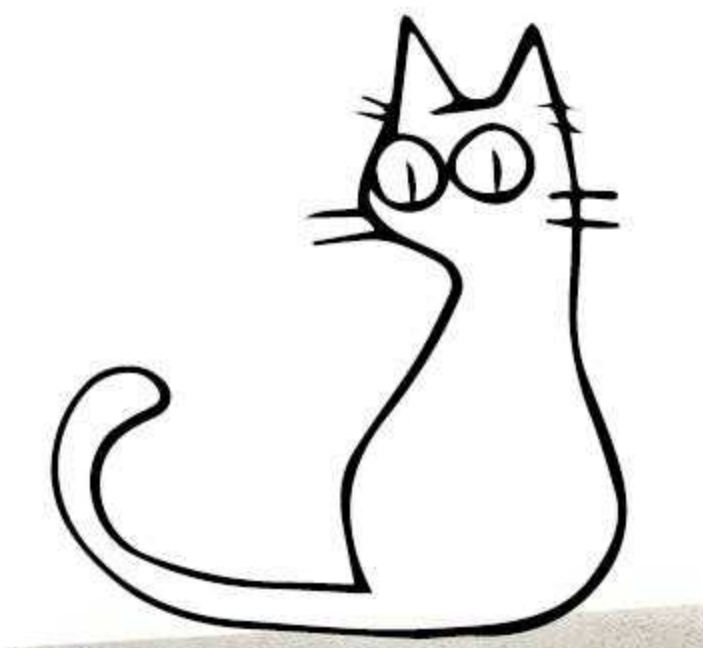

# APPLICATION CASES

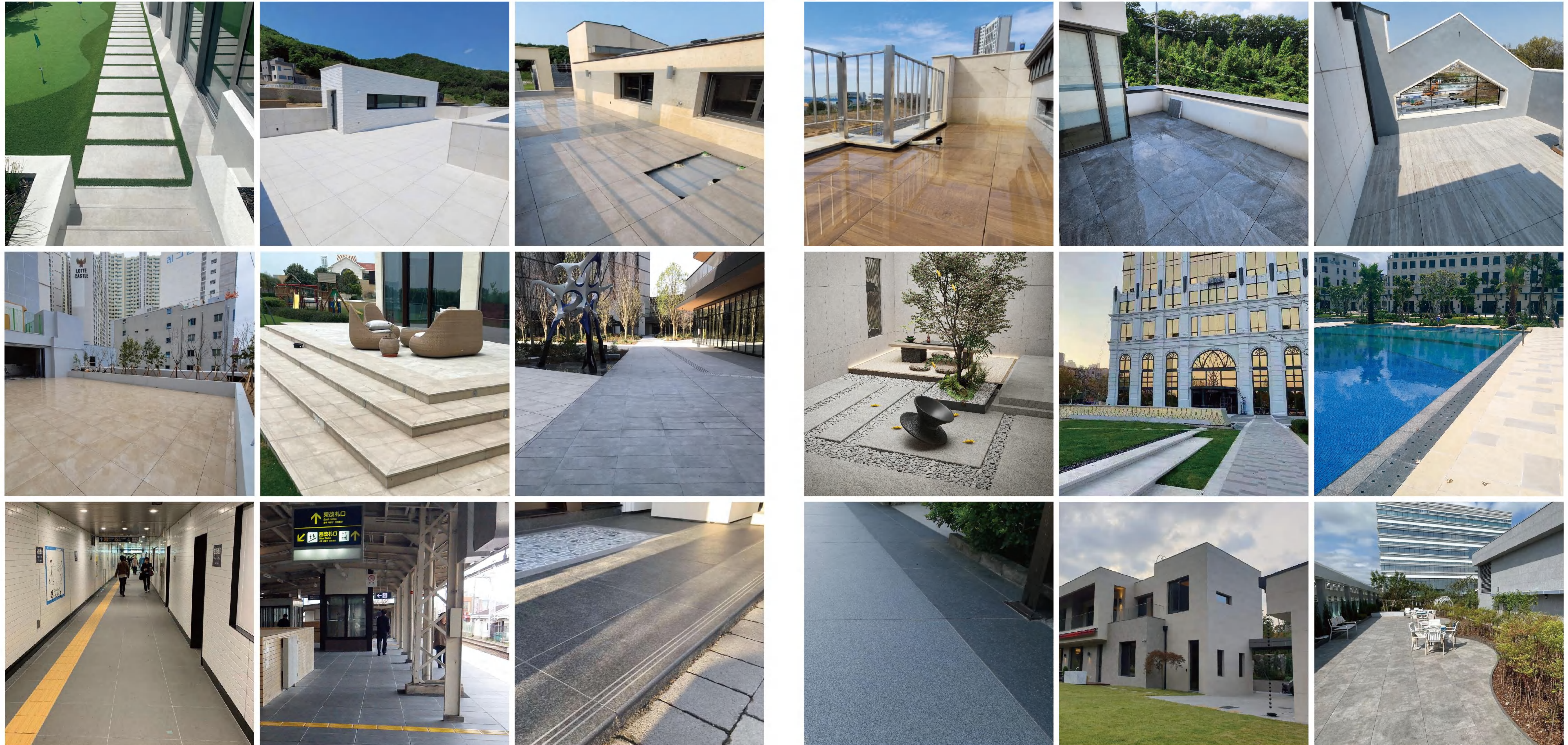

# COLLECTIONS

 10mm Indoor  
 20mm Outdoor

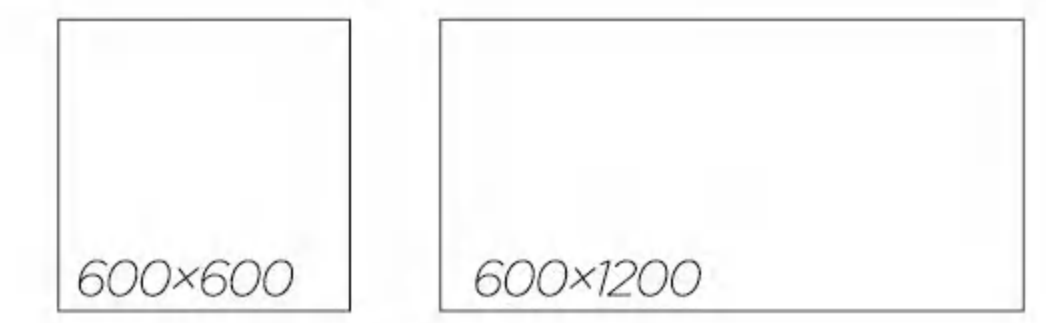

## Ales



K0603525DAZ  
600x600x20mm  
 10



K1263525DAZ  
600x1200x20mm  
 5



K0603516DAZ  
600x600x20mm  
 10

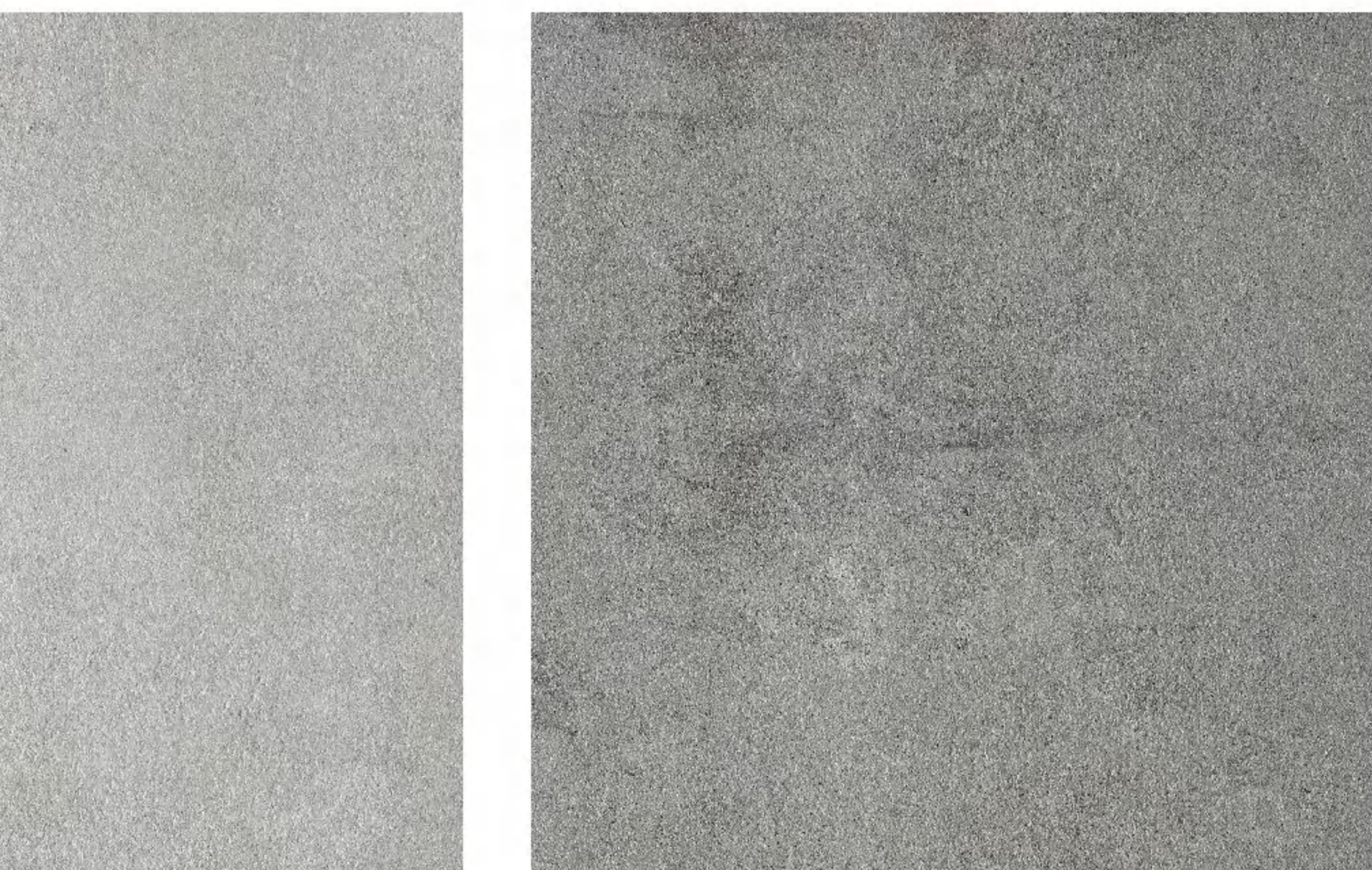

K1263516DAZ  
600x1200x20mm  
 5



K0603517DAZ  
600x600x20mm  
 10



K1263517DAZ  
600x1200x20mm  
 5

## Trani



K00608036ZAO  
600x600x20mm  
 5



K01268036ZAO  
600x1200x20mm  
 5



K00608037ZAO  
600x600x20mm  
 5

K00608039ZAO  
600x600x20mm  
 5

## Cement



K0603518DAZ  
600x600x20mm  
 10

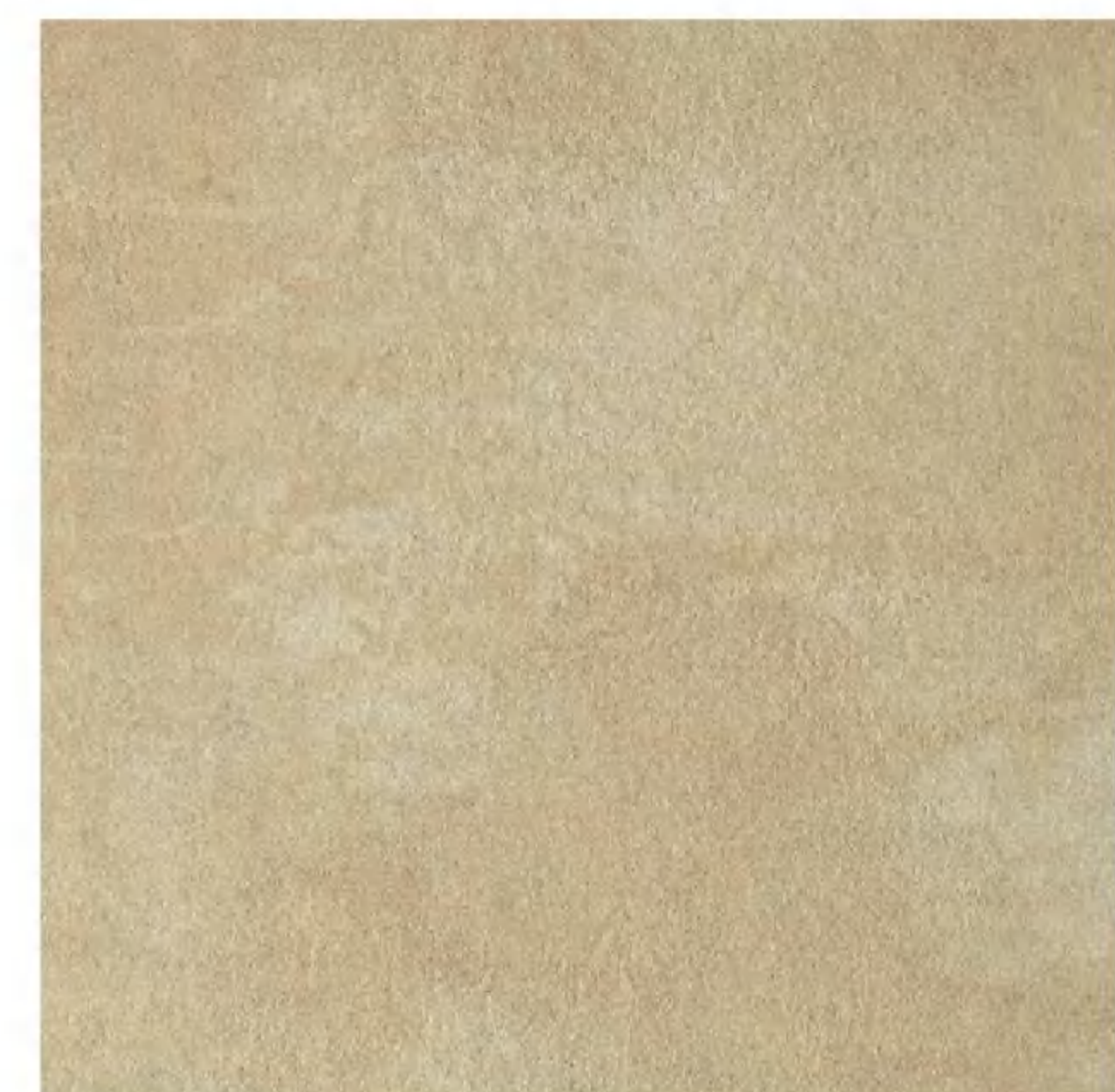

K0603519DAZ  
600x600x20mm  
 10

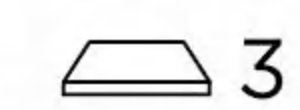

K0603704DAZ  
600x600x20mm  
 3



K1263704DAZ  
600x1200x20mm  
 1

K0606419DAZ  
600x600x20mm  
 7

# Sterling

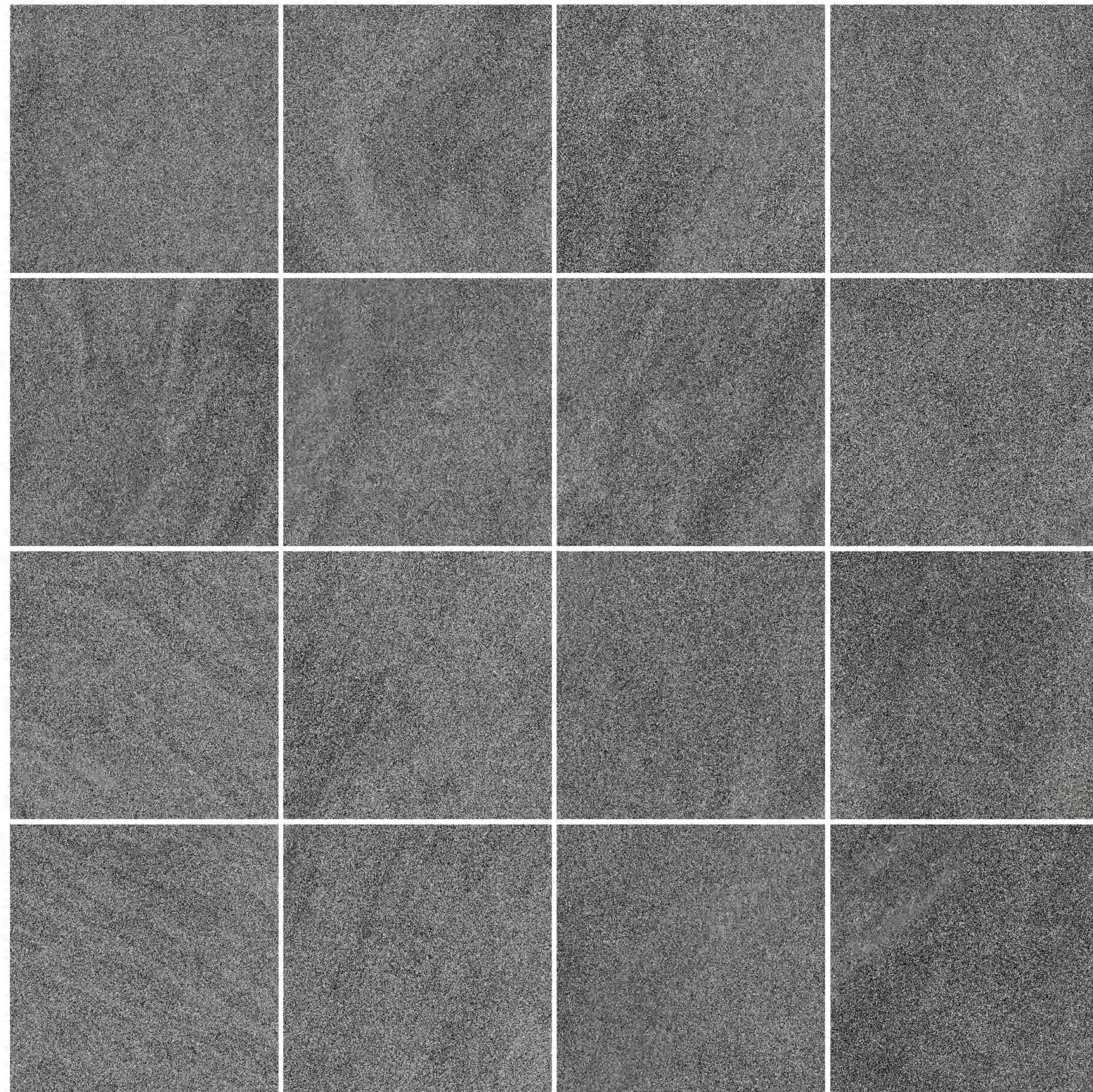

K00606100ZAO  
600×600×20mm

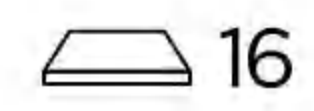

K00606097ZAO  
600×600×20mm

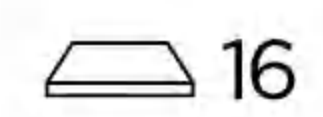

K00606098ZAO  
600×600×20mm

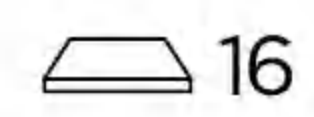

K00606099ZAO  
600×600×20mm

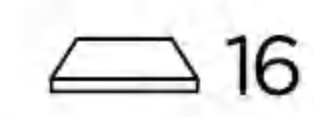

# Sandstone



K00606981ZAO  
600×600×20mm

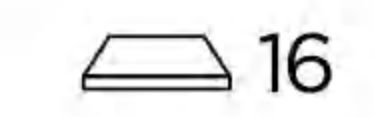

K00606980ZAO  
600×600×20mm

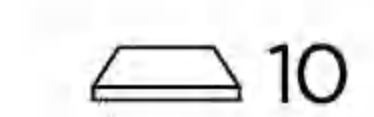

\* customized

20mm Outdoor

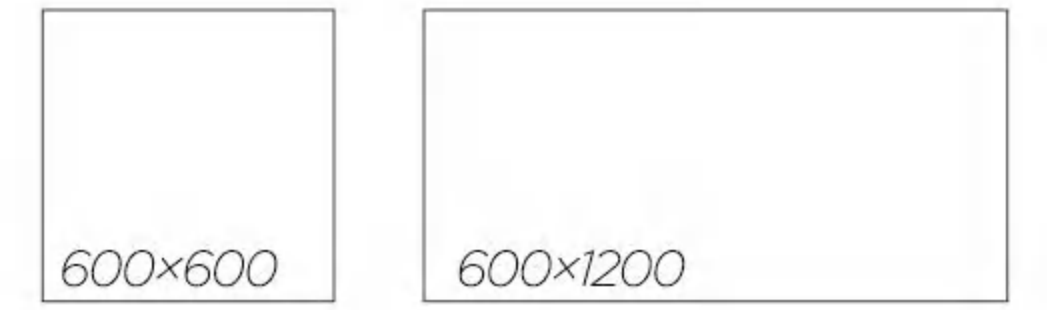

## Basalt Stone



K0606503DAZ  
600×600×20mm

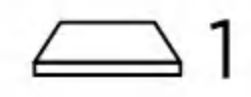

K1266503DAZ  
600×1200×20mm

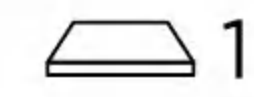

K0606033DAZ  
600×600×20mm



K1266033DAZ  
600×1200×20mm



K0606529DAZ  
600×600×20mm

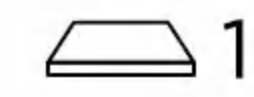

## Terrazzo

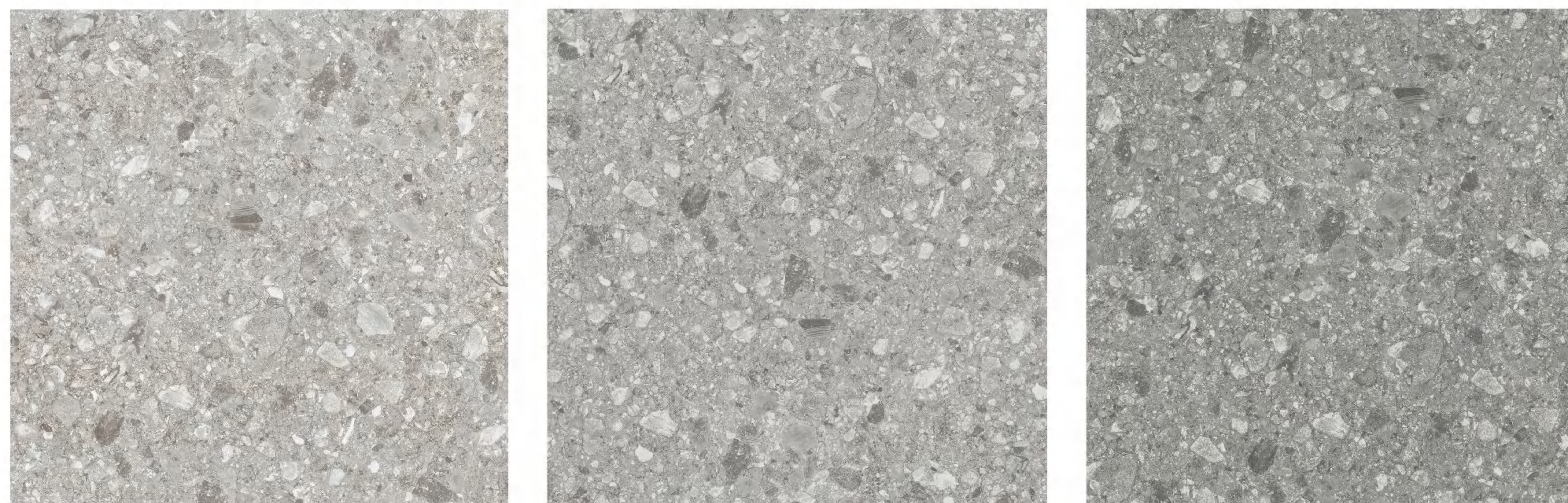

K00606976ZAO  
600×600×20mm

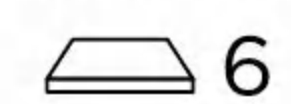

K00606977ZAO  
600×600×20mm

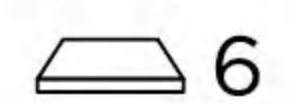

K00606978ZAO  
600×600×20mm

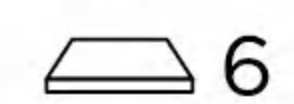

## Terrazzo



\* K0606801DAZ  
600×600×20mm



\* K00606894ZAO  
600×600×20mm

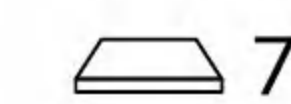

\* K00606893ZAO  
600×600×20mm

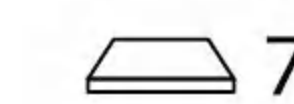

\* customized

20mm Outdoor

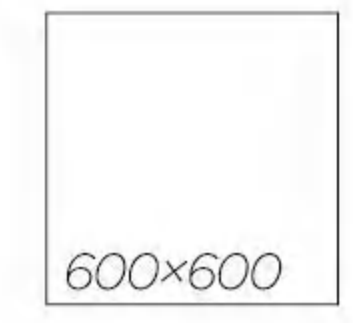

## Ivory Wood

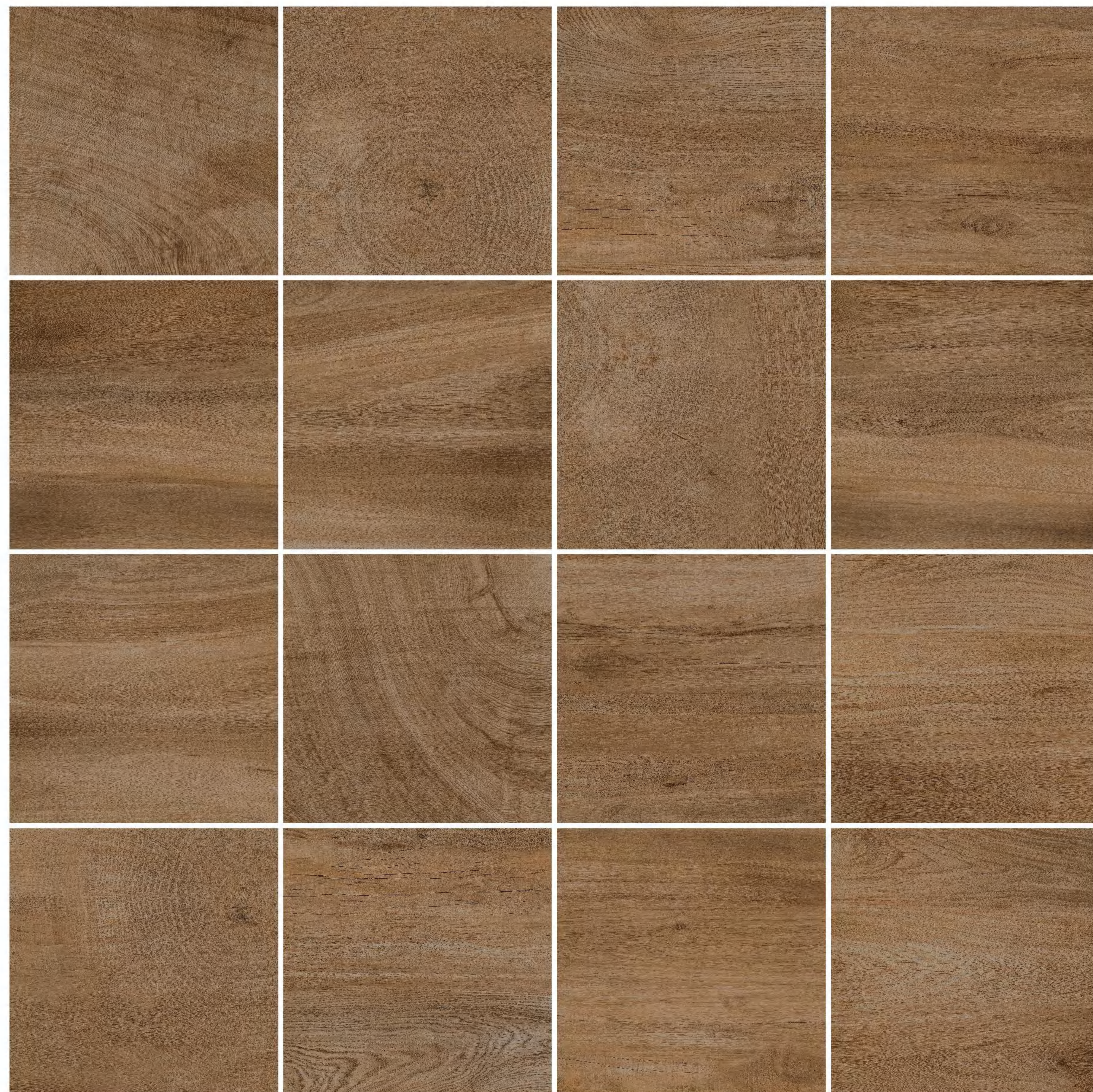

K00606979ZAO  
600×600×20mm  
16

## Cassero

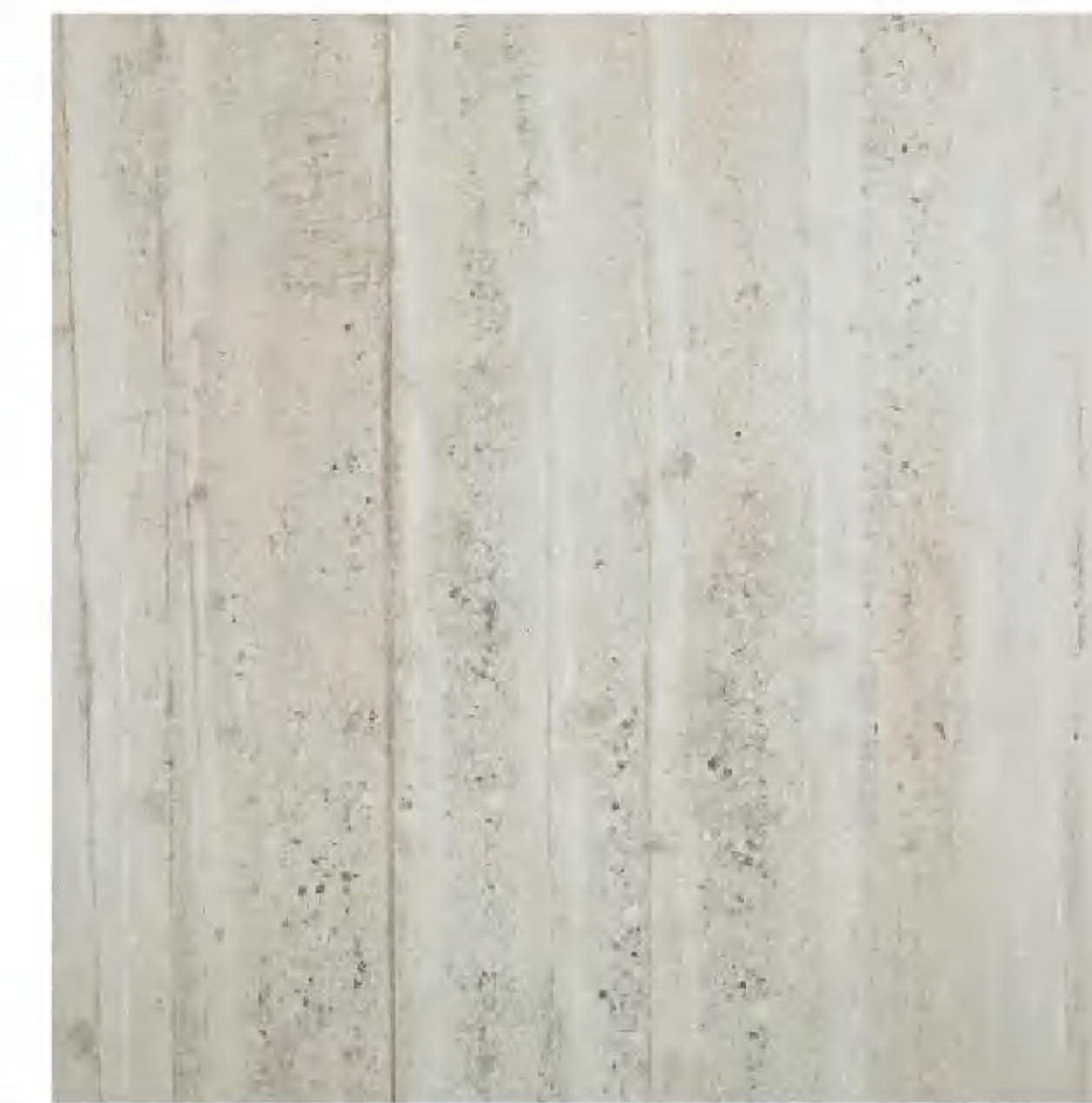

K0603520DAZ  
600×600×20mm  
12

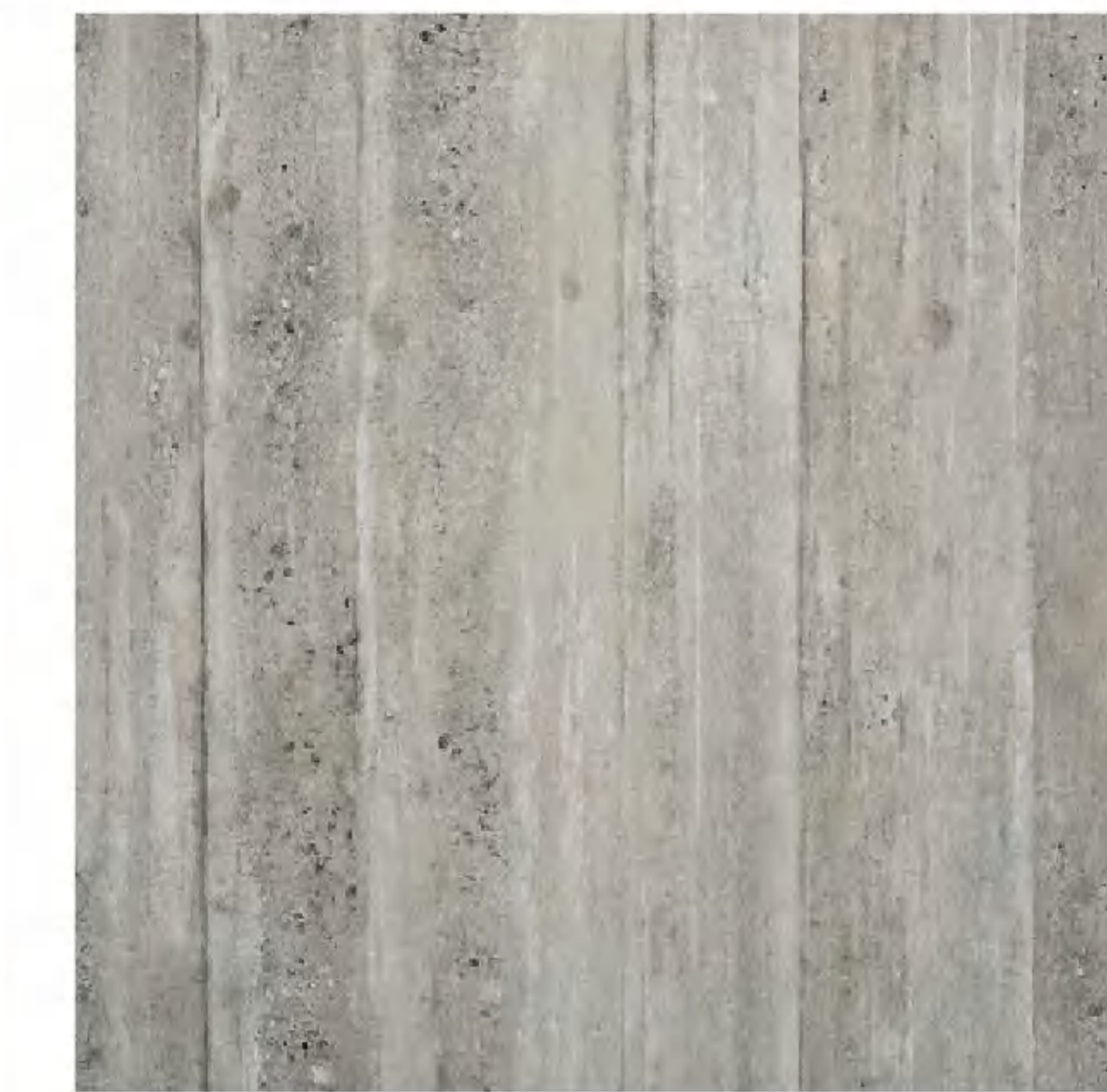

K0603522DAZ  
600×600×20mm  
12



\* K0603388DAZ  
600×600×20mm  
20

## Cararra



\* K0606542DAZ  
600×600×20mm  
10

## Sand Stone

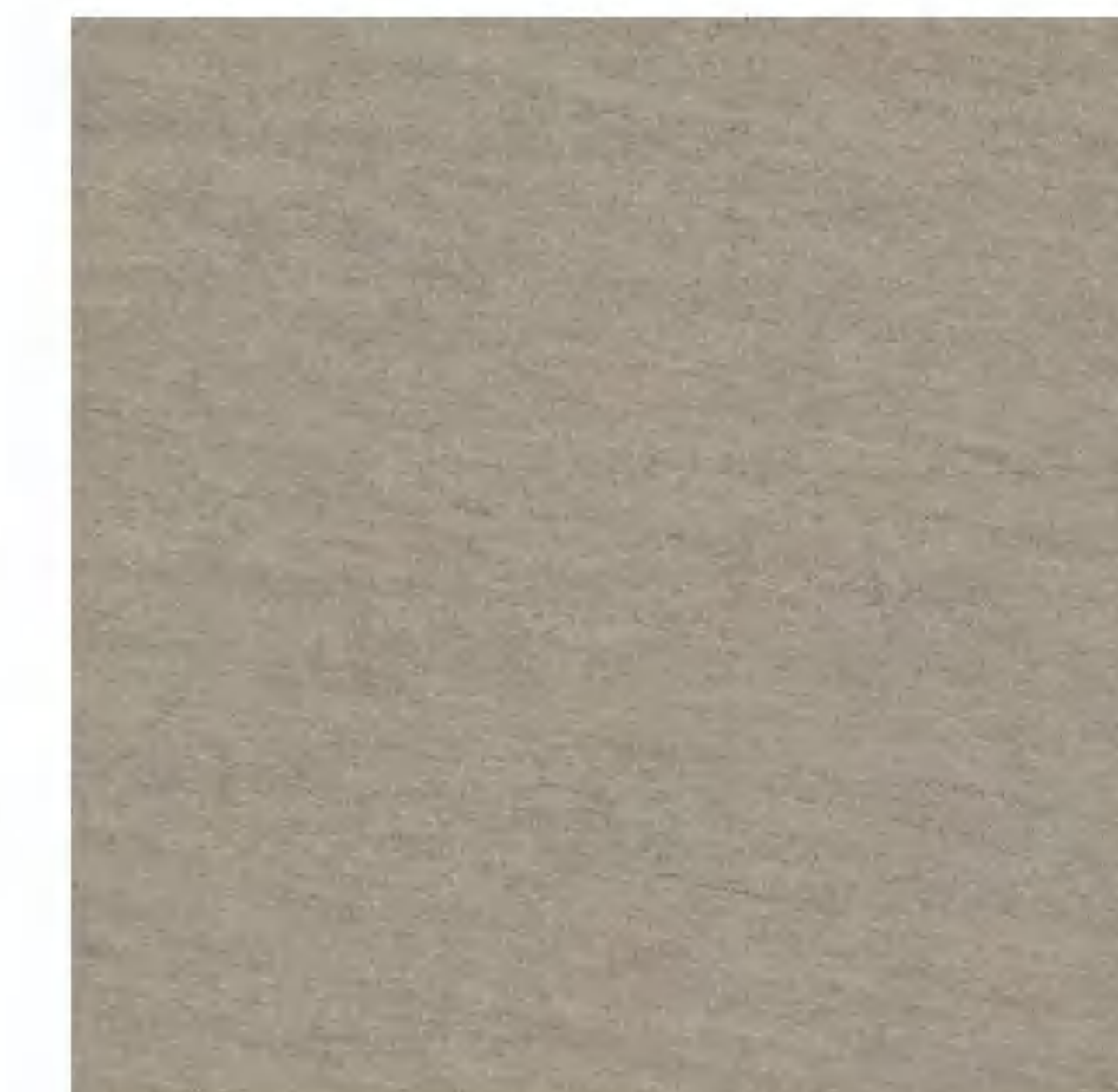

K0606527DAZ  
600×600×20mm  
5



\* K0606528DAZ  
600×600×20mm  
5





# ACCESSORIES

**Drop Face**

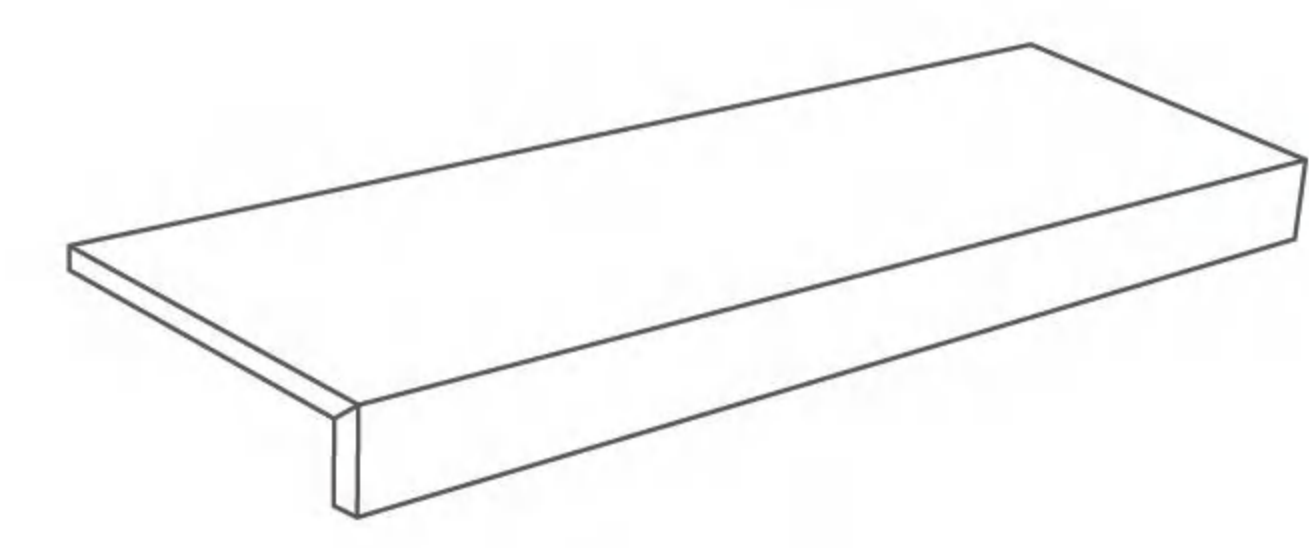

**Bullnose**

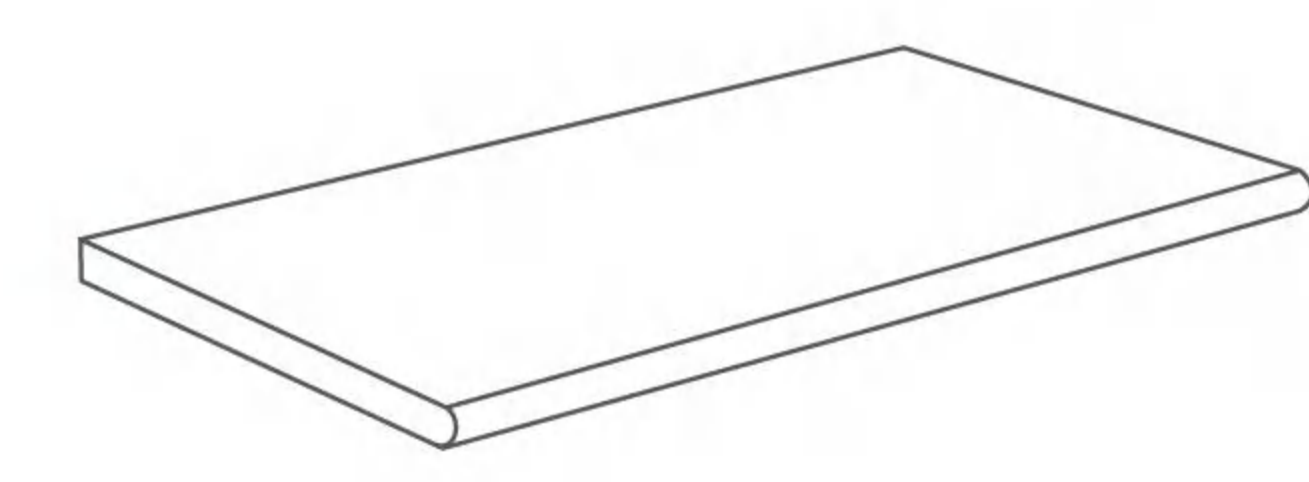

**Bullnose  
Build Up 20mm**

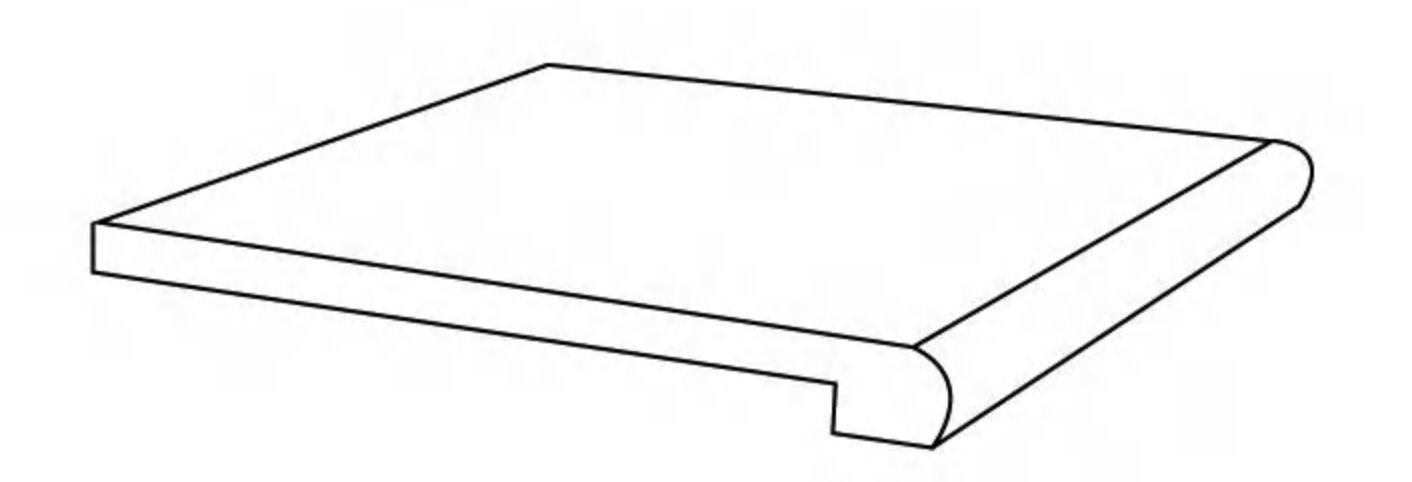

**Sink Tile A**

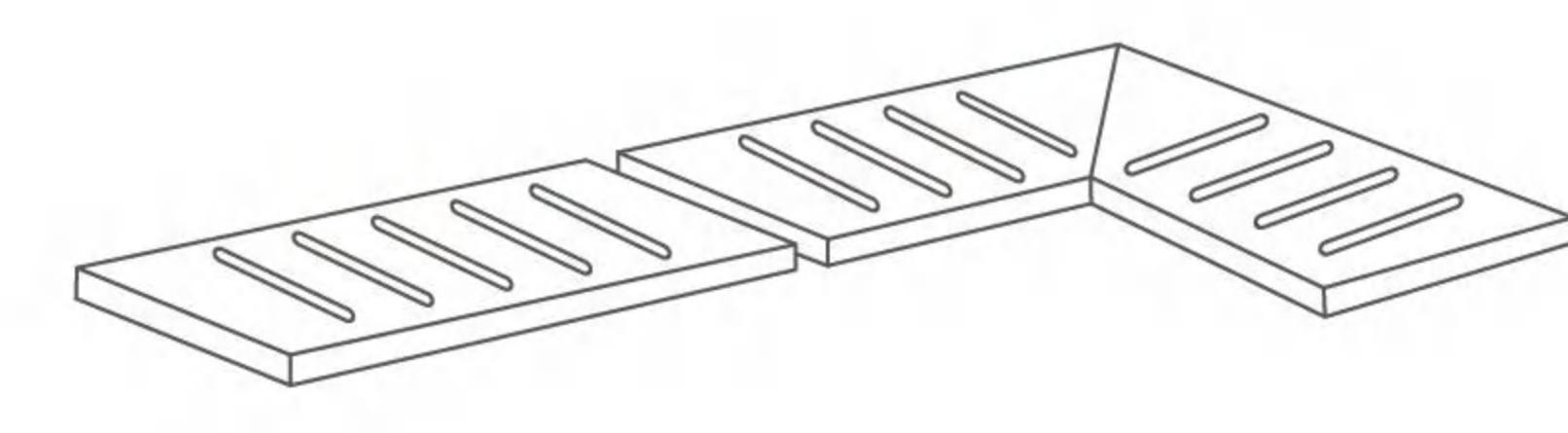

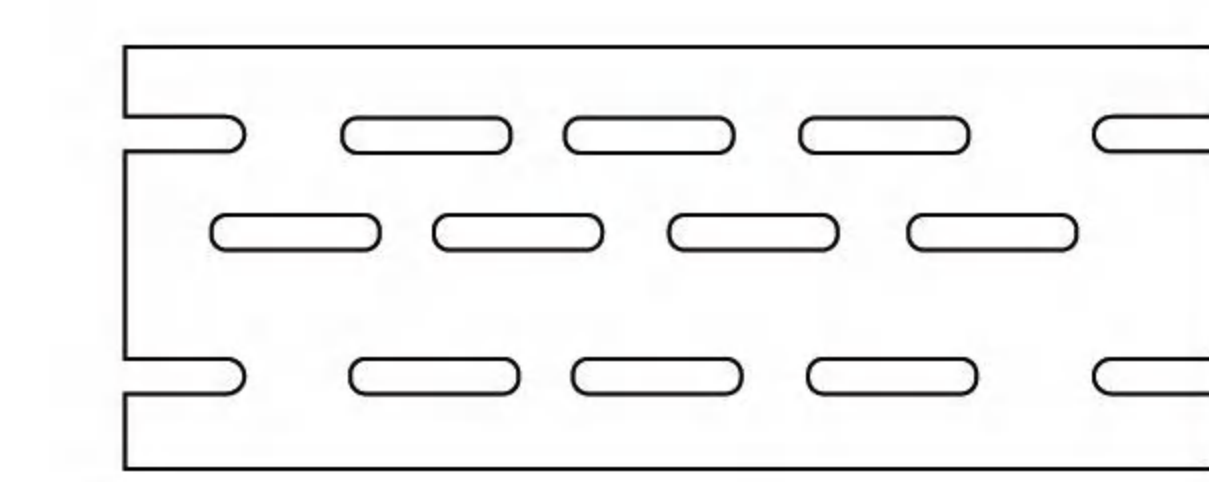

**Sink Tile B**

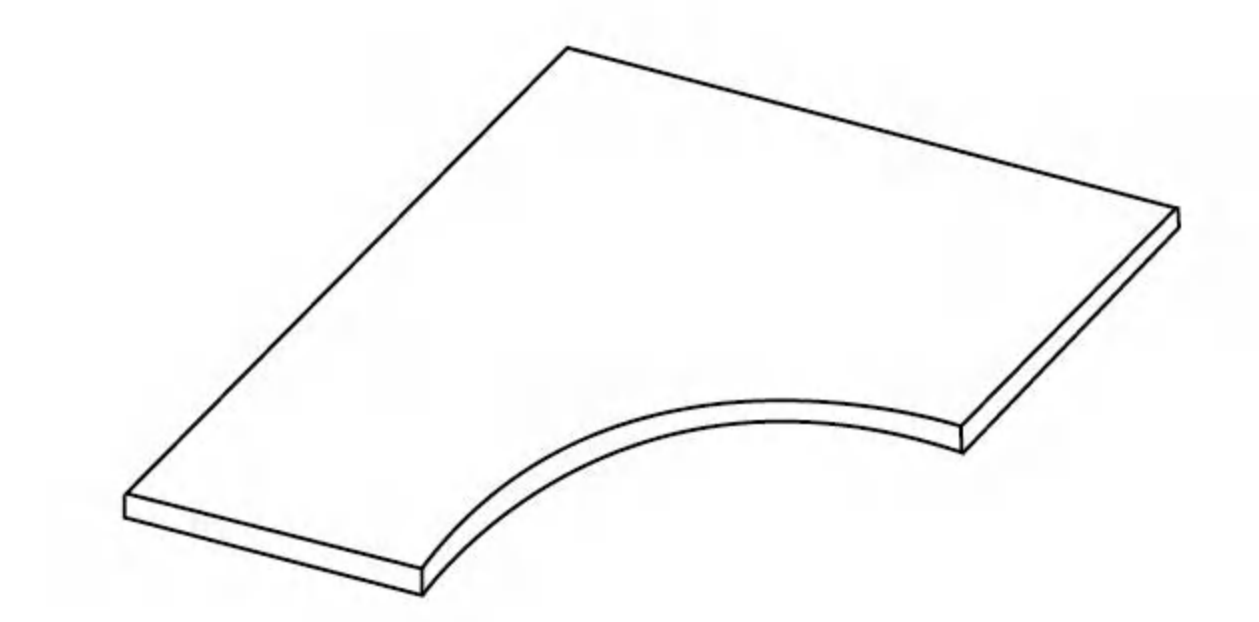

**Swimming Pool Deck Tile**

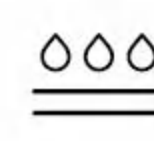

## TECHNICAL DATA

 Thickness	20mm
 Water Absorption	Less than 0.5%
 Breaking Strength	≥10200N
 Modulus of Rupture	Minimum ≥35N/mm <sup>2</sup>
 Static Coefficient of Friction	Dry: 0.87, Wet: 0.73
 DCOF	0.52
 PEI	Class 4
 Slipperiness	R11

**Steps**

Stairs tiles are available:  
Round edge step + riser / 45° chamfering step + riser

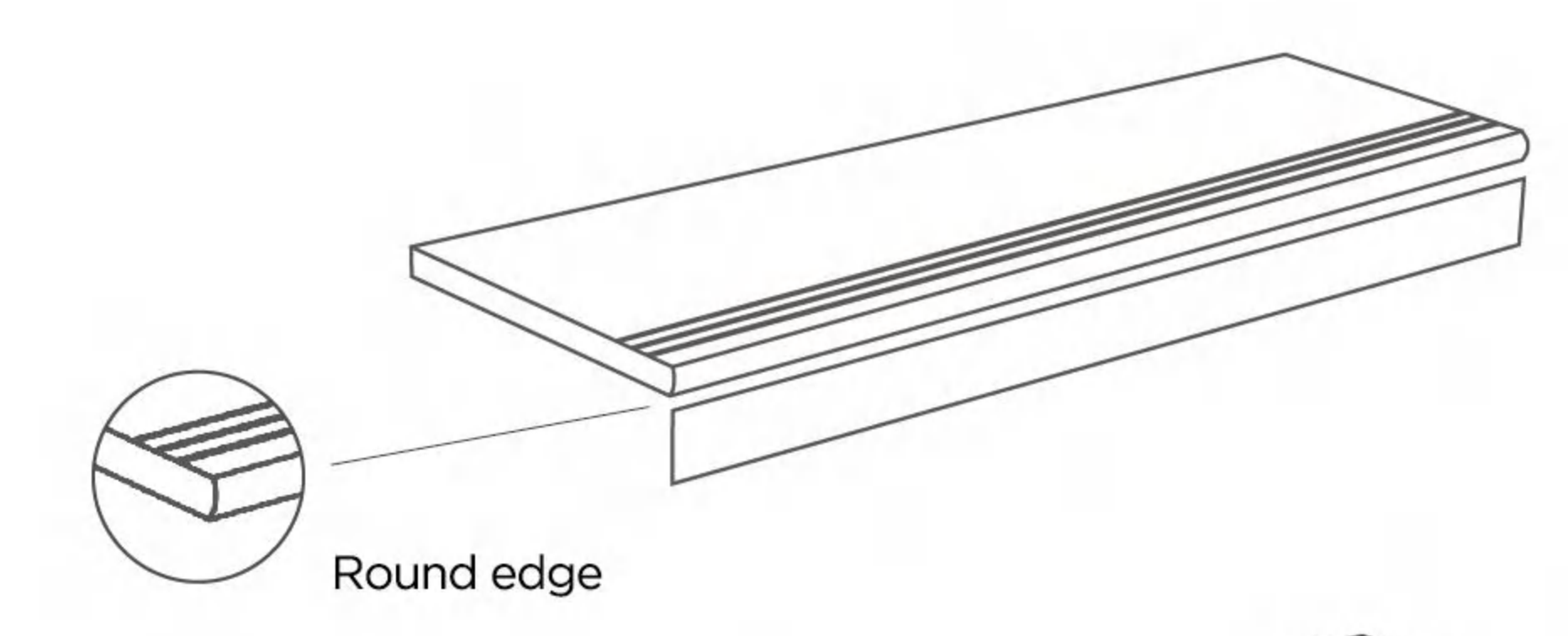

Round edge

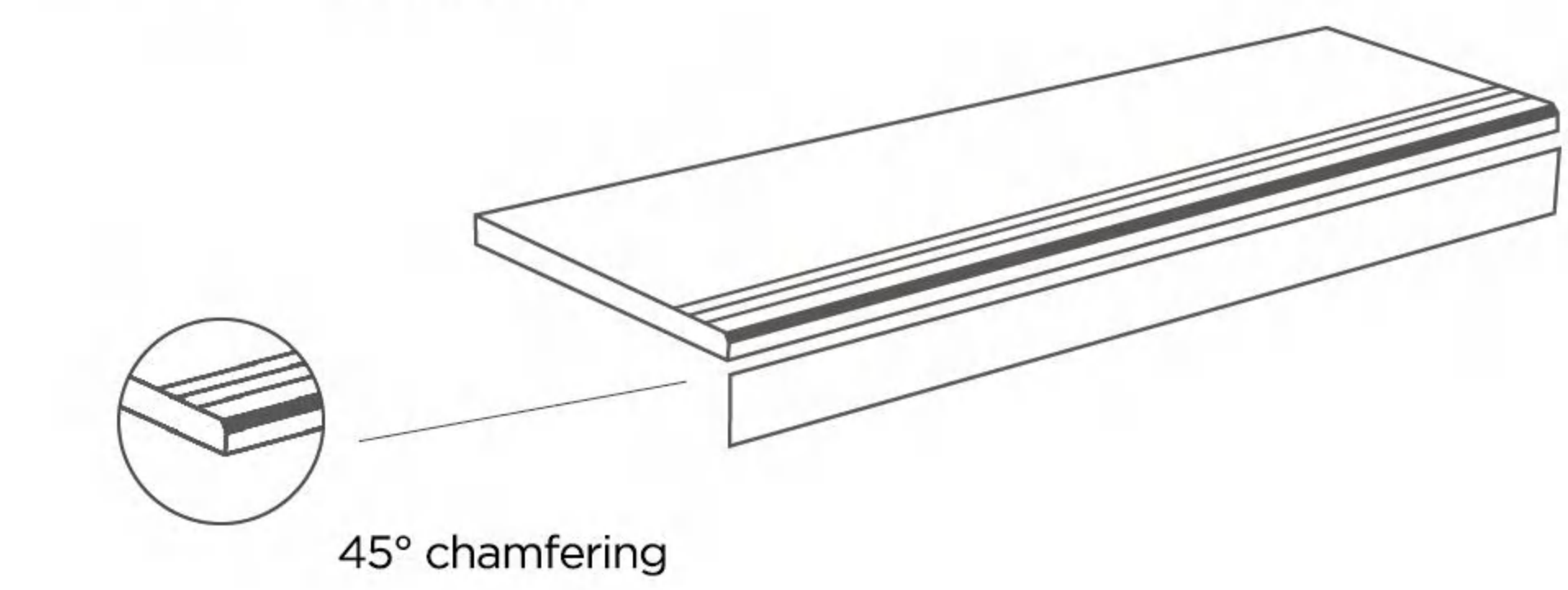





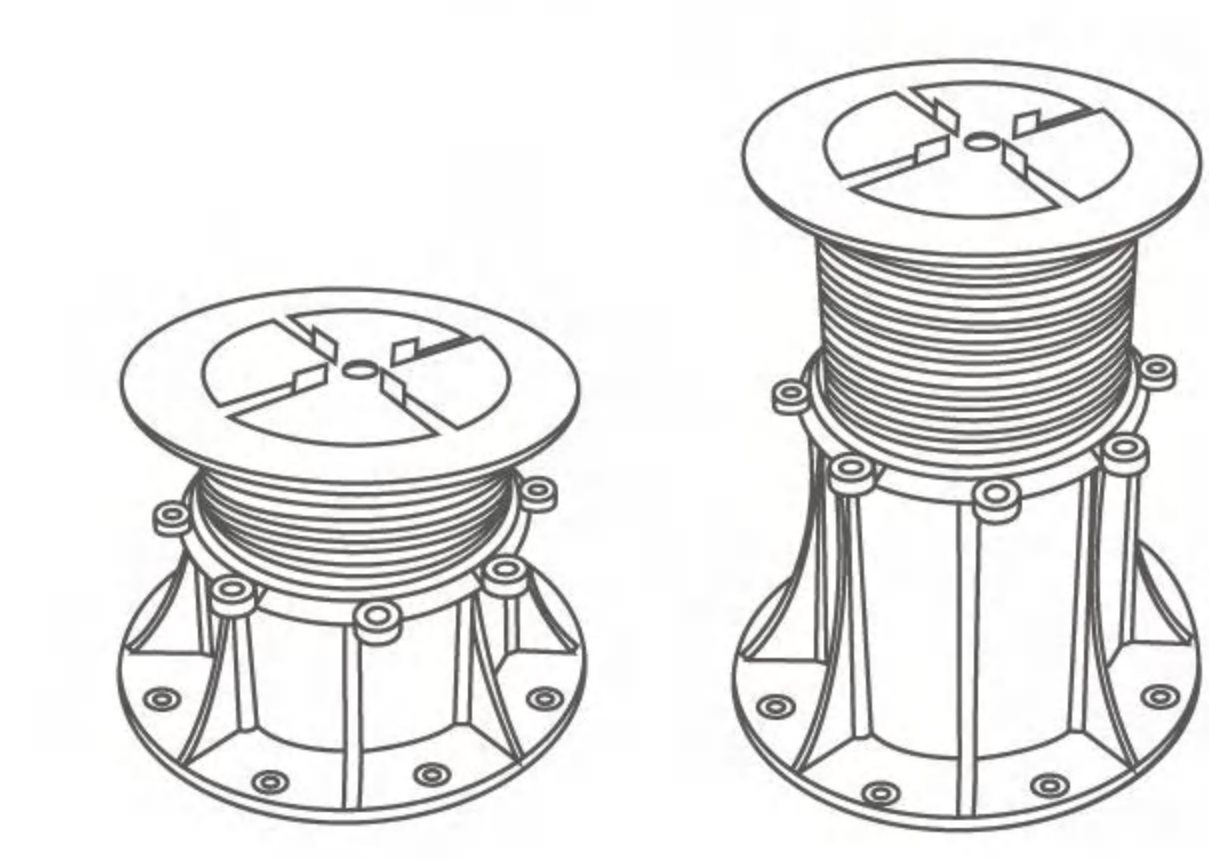





45° chamfering

**Plastic Pedestal**



# PACKING INFO

	Ctn Size	600×600×20mm	1200×600×20mm
	Pcs /Ctn	2	1
	M <sup>2</sup> /Ctn	0.72	0.72
	Kgs/Ctn	34	34
<hr/>			
	Pallet Size	1.1×1.1m	1.24x0.96m
	Ctns/Pat	40	32
	M <sup>2</sup> /Pat	28.8	23
	Kg/Pat	1360	1088
<hr/>			
	Ctns/Cont	800	768
	Pcs/Cont	576	552
	Kgs/Cont	27000	26112