

EP BATHROOM

Bathroom hardware

Bathroom Hardware

卫浴五金

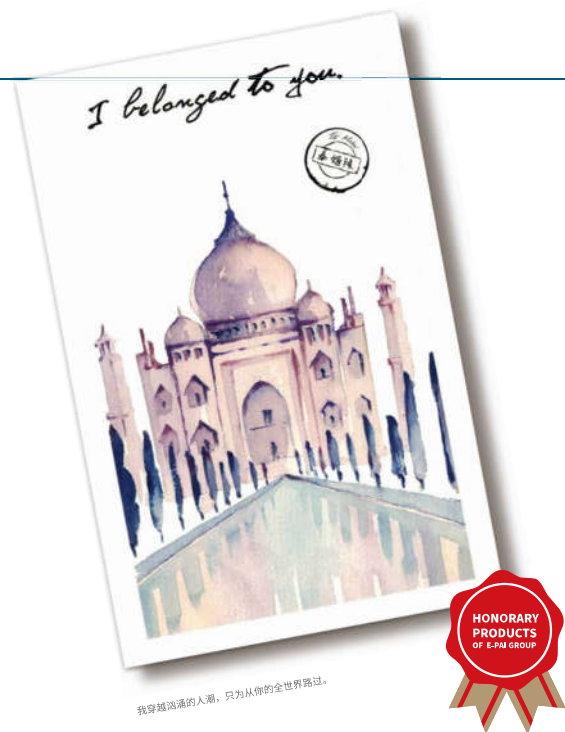

DOOR CLAMP

O E M & O D M E X P O R T

LIFE · TASTE

E - P a i

Show the dignity as
a king in the world



**Product
caption**

EPAI of the series of glass door clips is one of the high-end architectural decoration hardware accessories produced by NEWHUABAO Hardware Decoration Products Factory.

The product has beautiful appearance and is suitable for ordinary and tempered glass doors, wooden doors and aluminum alloy doors of hotels, shopping malls and office buildings.





BD113 Double Sided Shower Door Pull

Material	Finish
SUS 304 Stainless Steel	Brushed Stainless steel, Polished Stainless steel, Nickel, Black, Black gold
Diameter	3/4" (19mm)

304

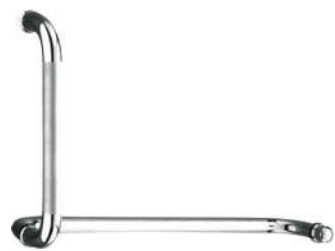

BP-013-BB
Bathroom Handle

Material
SUS 304 Stainless Steel

304



BP-013-BB
Bathroom Handle

Material
SUS 304 Stainless Steel

304



BP-013-BB
Bathroom Handle

Material
SUS 304 Stainless Steel

304



The technological process is more worthy of your taste in detail





BP-413

Bathroom Handle

Material
SUS 304 Stainless Steel

304



BP-413-sigle

Bathroom Handle

Material
SUS 304 Stainless Steel

304



BP-349

Bathroom Handle

Material
SUS 304 Stainless Steel

304



BP-345

Bathroom Handle

Material
SUS 304 Stainless Steel

304



BP-551-32

Bathroom Handle

Material
SUS 304 Stainless Steel

304



BP-550-19

Bathroom Handle

Material
SUS 304 Stainless Steel

304



BP-414-31

Bathroom Handle

Material
SUS 304 Stainless Steel

304



BP-319

Bathroom Handle

Material
SUS 304 Stainless Steel

304



BP-551L-28

Bathroom Handle

Material
SUS 304 Stainless Steel

304



BP-341

Bathroom Handle

Material
SUS 304 Stainless Steel

304



BP-268

Bathroom Handle

Material
SUS 304 Stainless Steel

304



BP-3153-32

Bathroom Handle

Material
SUS 304 Stainless Steel

304



BP-631-28

Bathroom Handle

Material
SUS 304 Stainless Steel

304





BP-551S-28
Bathroom Handle

Material
SUS 304 Stainless Steel

304



BP-158-25
Bathroom Handle

Material
SUS 304 Stainless Steel

304

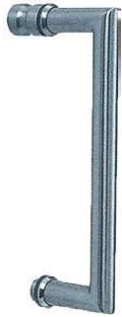

BP-3158F-26
Bathroom Handle

Material
SUS 304 Stainless Steel

304



BP-3113S-26
Bathroom Handle

Material
SUS 304 Stainless Steel

304



BP-163S-26
Bathroom Handle

Material
SUS 304 Stainless Steel

304



BP-1456

Material	Thickness
SUS 304 Stainless Steel	10-12mm Tempered glass
Scope of application	Suitable for bathroom glass doors

304

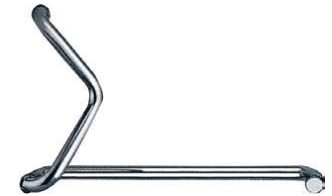

BP-1403

Material	Thickness
SUS 304 Stainless Steel	10-12mm Tempered glass
Scope of application	Suitable for bathroom glass doors

304

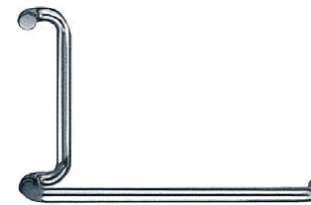

BP-153B

Material	Thickness
SUS 304 Stainless Steel	10-12mm Tempered glass
Scope of application	Suitable for bathroom glass doors

304



BP-3113M-30

Material	Thickness
SUS 304 Stainless Steel	10-12mm Tempered glass
Scope of application	Suitable for bathroom glass doors

304



BP-3146-19 Bathroom Handle

Material	Thickness
SUS 304 Stainless Steel	10-12mm Tempered glass
Scope of application	Suitable for bathroom glass doors

304



BP-3162

Material	Thickness
SUS 304 Stainless Steel	10-12mm Tempered glass
Scope of application Suitable for bathroom glass doors	
304	



BP-3149

Material	Thickness
SUS 304 Stainless Steel	10-12mm Tempered glass
Scope of application Suitable for bathroom glass doors	
304	



BP-3153

Material	Thickness	
SUS 304 Stainless Steel	10-12mm Tempered glass	
Scope of application Suitable for bathroom glass doors		
L	C/C	<input type="checkbox"/>
500	400	20X20
304		



BP-3153 -39

Material	Thickness	
SUS 304 Stainless Steel	10-12mm Tempered glass	
Scope of application Suitable for bathroom glass doors		
L	C/C	Φ
470	448	16
304		



BP-3112-24

Material	Thickness	
SUS 304 Stainless Steel	10-12mm Tempered glass	
Scope of application Suitable for bathroom glass doors		
L	C/C	<input type="checkbox"/>
600	450	23X14
304		

The Design Is Full Of Vigor And Vitality,
Unique Personality And Taste





KBH-001SS-64

Material	Thickness
SUS 304 Stainless Steel	10-12mm Tempered glass
Scope of application	Suitable for bathroom glass doors



KBH-002SS-64

Material	Thickness
SUS 304 Stainless Steel	10-12mm Tempered glass
Scope of application	Suitable for bathroom glass doors



EPKBH-007SS-50

Material	Thickness
SUS 304 Stainless Steel	10-12mm Tempered glass
Scope of application	Suitable for bathroom glass doors



KBH-008SS-50

Material	Thickness
SUS 304 Stainless Steel	10-12mm Tempered glass
Scope of application	Suitable for bathroom glass doors



KBH-001SS-59

Material	Thickness
SUS 304 Stainless Steel	10-12mm Tempered glass
Scope of application	Suitable for bathroom glass doors



KBH-002SS-59

Material	Thickness
SUS 304 Stainless Steel	10-12mm Tempered glass
Scope of application	Suitable for bathroom glass doors



KBH-009SS

Material	Thickness
SUS 304 Stainless Steel	10-12mm Tempered glass
Scope of application	Suitable for bathroom glass doors

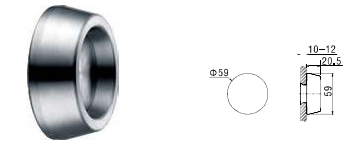

KBH-010SS

Material	Thickness
SUS 304 Stainless Steel	10-12mm Tempered glass
Scope of application	Suitable for bathroom glass doors



KBH-003SS-65

Material	Thickness
SUS 304 Stainless Steel	10-12mm Tempered glass
Scope of application	Suitable for bathroom glass doors



KBH-004SS-65

Material	Thickness
SUS 304 Stainless Steel	10-12mm Tempered glass
Scope of application	Suitable for bathroom glass doors



KBH-011SS-50

Material	Thickness
SUS 304 Stainless Steel	10-12mm Tempered glass
Scope of application	Suitable for bathroom glass doors



KBH-012SS

Material	Thickness
SUS 304 Stainless Steel	10-12mm Tempered glass
Scope of application	Suitable for bathroom glass doors

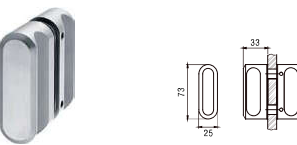

KBH-005SS-73

Material	Thickness
SUS 304 Stainless Steel	10-12mm Tempered glass
Scope of application	Suitable for bathroom glass doors



KBH-006SS

Material	Thickness
SUS 304 Stainless Steel	10-12mm Tempered glass
Scope of application	Suitable for bathroom glass doors



KBH-013SS

Material	Thickness
SUS 304 Stainless Steel	10-12mm Tempered glass
Scope of application	Suitable for bathroom glass doors



KBH-014SS

Material	Thickness
SUS 304 Stainless Steel	10-12mm Tempered glass
Scope of application	Suitable for bathroom glass doors



KBH-016SS-28 Bathroom Handle
Material SUS 304 Stainless Steel
Thickness 10-12mm Tempered glass
Scope of application Suitable for bathroom glass doors
 304



KBH-017SS-31 Bathroom Handle
Material SUS 304 Stainless Steel
Thickness 10-12mm Tempered glass
Scope of application Suitable for bathroom glass doors
 304



KBH-024SS-30 Bathroom Handle
Material SUS 304 Stainless Steel
Thickness 10-12mm Tempered glass
Scope of application Suitable for bathroom glass doors
 304



KBH-025SS-32 Bathroom Handle
Material SUS 304 Stainless Steel
Thickness 10-12mm Tempered glass
Scope of application Suitable for bathroom glass doors
 304



KBH-018SS-28 Bathroom Handle
Material SUS 304 Stainless Steel
Thickness 10-12mm Tempered glass
Scope of application Suitable for bathroom glass doors
 304



KBH-019SS-26 Bathroom Handle
Material SUS 304 Stainless Steel
Thickness 10-12mm Tempered glass
Scope of application Suitable for bathroom glass doors
 304



KBH-026SS-26 Bathroom Handle
Material SUS 304 Stainless Steel
Thickness 10-12mm Tempered glass
Scope of application Suitable for bathroom glass doors
 304

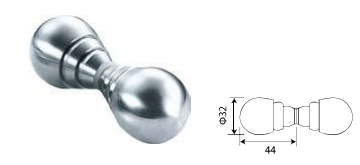

KBH-027SS-24 Bathroom Handle
Material SUS 304 Stainless Steel
Thickness 10-12mm Tempered glass
Scope of application Suitable for bathroom glass doors
 304



KBH-020SS-25 Bathroom Handle
Material SUS 304 Stainless Steel
Thickness 10-12mm Tempered glass
Scope of application Suitable for bathroom glass doors
 304



KBH-021SS-28 Bathroom Handle
Material SUS 304 Stainless Steel
Thickness 10-12mm Tempered glass
Scope of application Suitable for bathroom glass doors
 304



KBH-028SS-30 Bathroom Handle
Material SUS 304 Stainless Steel
Thickness 10-12mm Tempered glass
Scope of application Suitable for bathroom glass doors
 304



KBH-029SS-30 Bathroom Handle
Material SUS 304 Stainless Steel
Thickness 10-12mm Tempered glass
Scope of application Suitable for bathroom glass doors
 304



KBH-022SS-25 Bathroom Handle
Material SUS 304 Stainless Steel
Thickness 10-12mm Tempered glass
Scope of application Suitable for bathroom glass doors
 304



KBH-023SS-19 Bathroom Handle
Material SUS 304 Stainless Steel
Thickness 10-12mm Tempered glass
Scope of application Suitable for bathroom glass doors
 304



KBH-030SS-19 Bathroom Handle
Material SUS 304 Stainless Steel
Thickness 10-12mm Tempered glass
Scope of application Suitable for bathroom glass doors
 304



KBH-031SS-28 Bathroom Handle
Material SUS 304 Stainless Steel
Thickness 10-12mm Tempered glass
Scope of application Suitable for bathroom glass doors
 304

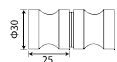

KBH-032SS-25 Bathroom Handle

Material	Thickness
SUS 304 Stainless Steel	10-12mm Tempered glass
Scope of application	Suitable for bathroom glass doors

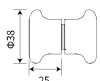

KBH-034SS-25 Bathroom Handle

Material	Thickness
SUS 304 Stainless Steel	10-12mm Tempered glass
Scope of application	Suitable for bathroom glass doors

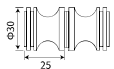

KBH-026SS-24 Bathroom Handle

Material	Thickness
SUS 304 Stainless Steel	10-12mm Tempered glass
Scope of application	Suitable for bathroom glass doors

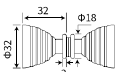

KBH-038SS-30 Bathroom Handle

Material	Thickness
SUS 304 Stainless Steel	10-12mm Tempered glass
Scope of application	Suitable for bathroom glass doors

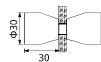

KBH-033SS-28 Bathroom Handle

Material	Thickness
SUS 304 Stainless Steel	10-12mm Tempered glass
Scope of application	Suitable for bathroom glass doors

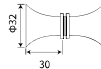

KBH-035SS-22 Bathroom Handle

Material	Thickness
SUS 304 Stainless Steel	10-12mm Tempered glass
Scope of application	Suitable for bathroom glass doors

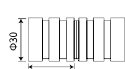

KBH-037SS-30 Bathroom Handle

Material	Thickness
SUS 304 Stainless Steel	10-12mm Tempered glass
Scope of application	Suitable for bathroom glass doors



CARVED EXQUISITE LIFE



EPTR-01-001 Towel Rack

Material
SUS 304 Stainless Steel
304



EPTR-01-002 Towel Rack

Material
SUS 304 Stainless Steel
304



EPTR-01-003 Towel Rack

Material
SUS 304 Stainless Steel
304



EPTR-02-001 Towel Rack

Material
SUS 304 Stainless Steel
304



EPTR-02-002 Towel Rack

Material
SUS 304 Stainless Steel
304



EPTR-02-003 Towel Rack

Material
SUS 304 Stainless Steel
304



EPTR-01-004 Towel Rack

Material
SUS 304 Stainless Steel
304



EPTR-01-005 Towel Rack

Material
SUS 304 Stainless Steel
304



EPTR-02-006 Towel Rack

Material
SUS 304 Stainless Steel
304



EPTR-02-007 Towel Rack

Material
SUS 304 Stainless Steel
304



EPTR-01-006 Towel Rack

Material
SUS 304 Stainless Steel
304



EPTR-01-008 Towel Rack

Material
SUS 304 Stainless Steel
304



EPTR-02-005 Towel Rack

Material
SUS 304 Stainless Steel
304



EPTR-02-008 Towel Rack

Material
SUS 304 Stainless Steel
304

Carlota *pai*

Shower Box 31

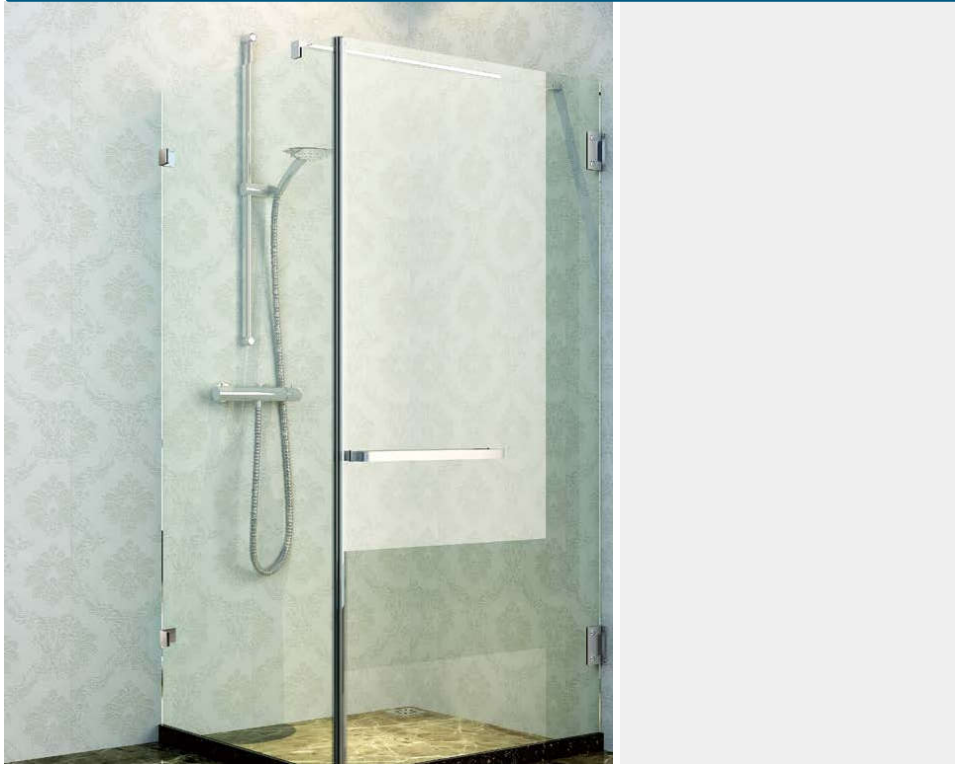

Installation Necessary fitting



EPGC-01-5050
M2-Pulley Wheel



EPGC-2111
Shower hinge



BP-412
Door Handle



BRC-003-R1
Shower Supporting Bar

Therese *pai*

Shower Box 34



Installation Necessary fitting



M2-206
Guide Track



KBH-031SS-28
Door handle



4212-Doule
Shower hinge



GC-03-90°
Glass Comedor



M2-201
M2-Pulley Wheel



M2-202
Guide Rail Fiaing Black



M2-207
Mounting



Guide Rail

Scarlett^{pai}

Shower Box 41

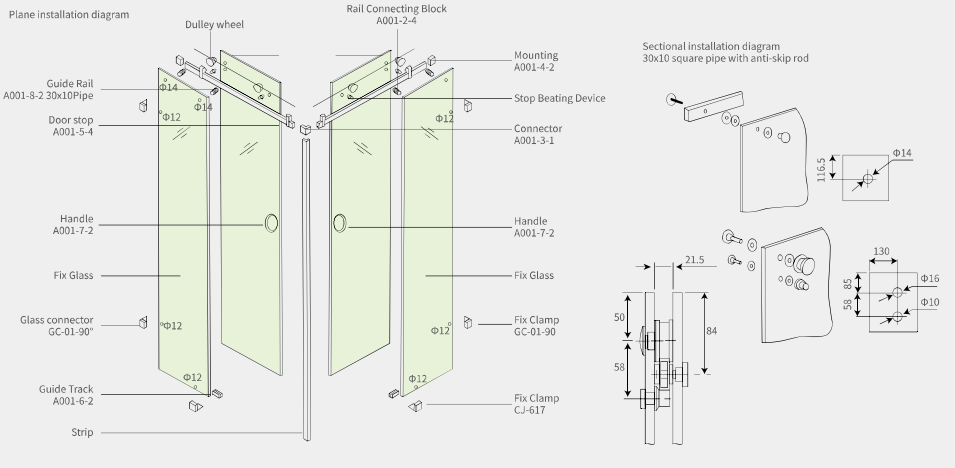

Installation Necessary fitting



Shower Box 41

Nonstandard shower room installation diagram

Instructions:

- Maximum weight wearing of the shower room: 65kg
- 180° maximum installation length is 2m; 90° dual-open door maximum installation length is 1.0m
- There are no drilled holes in the guide rails ordered by users; holes shall be made during installation
- The accessories are only suitable for clamping 8mm-10mm glass.
- When drilling holes in glass, please do strictly in accordance with dimensions in the installation diagram.
- Every type can install 90° dual-open, 90° single-open and 180°

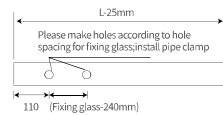

Shower Box 41



Chanel *pai*

Shower Box 86

Plane installation diagram

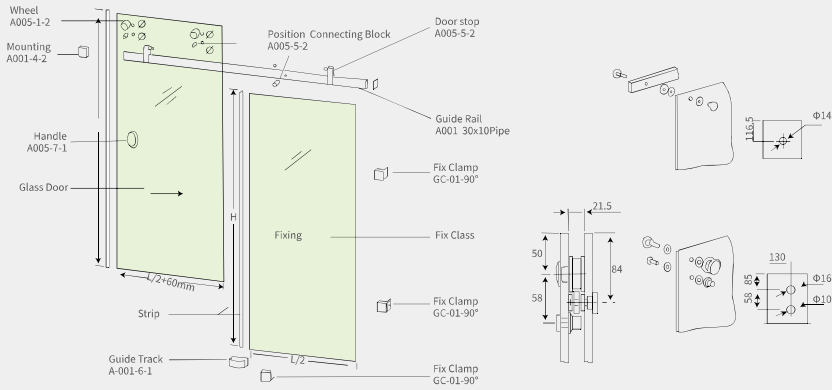

Installation Necessary fitting



Shower Box 86

Nonstandard shower room installation diagram

Instructions:

- Maximum weight wearing of the shower room : 65kg
- 180° maximum installation length is 2m; 90° dual-open door maximum installation length is 1.0m
- There are no drilled holes in the guide rails ordered by users.holes shall be made during installation
- The accessories are only suitable for clamping 8mm-10mm glass.
- When drilling holes in glass, please do strictly in accordance with dimensions in the installation diagram.
- Every type can install 90° dual-open,90° single-open and 180°

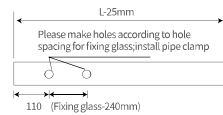

Shower Box 86



Daria pai

Shower Box 68

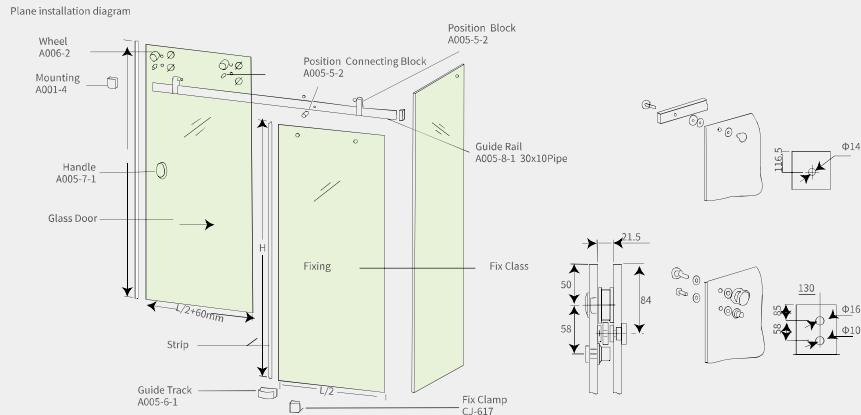

Installation Necessary fitting



Shower Box 68

Nonstandard shower room installation diagram

Instructions:

- Maximum weight wearing of the shower room: 65kg
- 180° maximum installation length is 2m; 90° dual-open door maximum installation length is 1.0m
- There are no drilled holes in the guide rails ordered by users. Holes shall be made during installation
- The accessories are only suitable for clamping 8mm-10mm glass.
- When drilling holes in glass, please do strictly in accordance with dimensions in the installation diagram.
- Every type can install 90° dual-open, 90° single-open and 180°

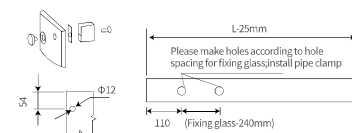

Shower Box 68



Shower Box 76

Plane installation diagram

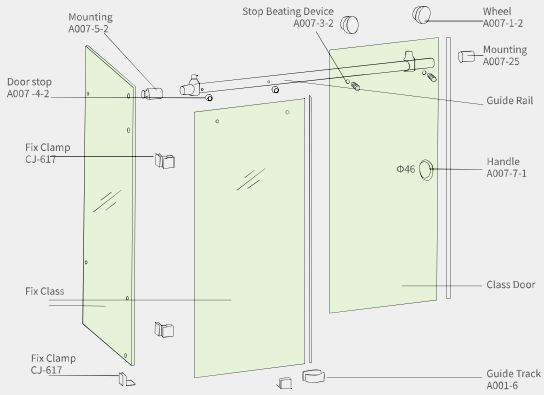

Sectional installation diagram
Φ25 pipe bathroom hanging wheel

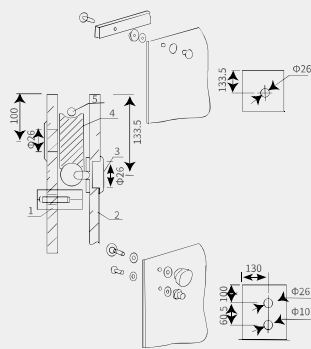

Installation Necessary fitting



A007-1
Pulley wheel



A007-3
Guide Bail Fixing



A007-2
Stop beating device



A007-4
Door stop



A007-5
Mounting



A001-6
Guide Track



Handle



A007-25
Bar



GC-01-90°
Guide Track

Shower Box 76

Nonstandard shower room installation diagram

Instructions:

- Maximum weight wearing of the shower room : 85kg
- 180° maximum installation length is 2m; 90° dual-open door maximum installation length is 1.0m
- There are no drilled holes in the guide rails ordered by users.holes shall be made during installation
- The accessories are only suitable for clamping 8mm-10mm glass.
- When drilling holes in glass, please do strictly in accordance with dimensions in the installation diagram.
- Every type can install 90° dual-open,90° single-open and 180°



Shower Box 76



Beatrice *pai*

Shower Box 39

Plane installation diagram

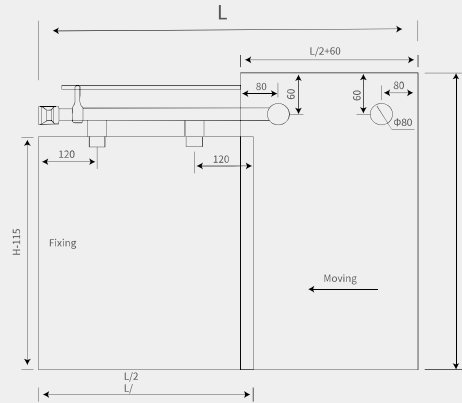

Setional installation diagram

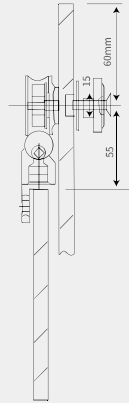

Installation Necessary fitting



Shower Box 39

Nonstandard shower room installation diagram

Instructions:

- Maximum weight wearing of the shower room : 65kg
- 180° maximum installation length is 2m ; 90° dual-open door maximum installation length is 1.0m
- There are no drilled holes in the guide rails ordered by users.holes shall be made during installation
- The accessories are only suitable for clamping 8mm-10mm glass.
- When drilling holes in glass, please do strictly in accordance with dimensions in the installation diagram.
- Every type can install 90° dual-open,90° single-open and 180°

Shower Box 39



Athena *pai*



Athena *pai*



HB-99100A

Necessary fitting **Installation** **Installation** Necessary fitting

HB-99100A



A007-1



A007-3-2



A007-2



A001-4
M2-Mounting



A005-5
Door Stop



A001-6
Guide Track



A0007-1



A007-3-2



A007-2



A001-4
M2-Mounting



A005-5
Door Stop



Handle



Guide Rail



GC-01-90°
Guide Track



A001-3
Mounting



A001-6
Guide Track



Handle



Guide Rail



M2-507
Guide Track

Astrid pai



Plane installation diagram

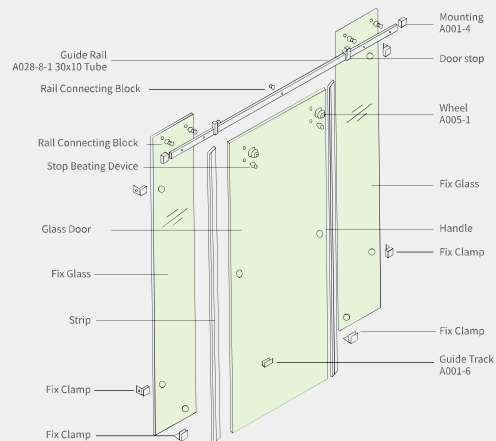

Installation Necessary fitting



A005-1
Pulley Wheel



A004-4
Guide Rail Fixing Block



A006-01



A001-4
Mounting



A005-5
Door Stop



A001-6
Guide Track



Handle



AC-1-3010
Guide Rail



GC-1-90°
Guide Track

Modle2-2601

Nonstandard shower room installation diagram

Instructions:

- Maximum weight wearing of the shower room: 75kg
- 180° maximum installation length is 3m;
- There are no drilled holes in the guide rails ordered by users.
Holes shall be made during installation
- The accessories are only suitable for clamping 8mm-10mm glass.
- When drilling holes in glass, please do strictly in accordance with dimensions in the installation diagram.
- Every type can install 90° dual-open, 90° single-open and 180°

Modle 02-2601



Barbarapai

Shower Box 94

Installation Necessary fitting



A901
Mounting



A902
Fixing Block



Handle



Shower hinge



Active Fixing Block



Fixing Rod



Fiona pai

Shower Box 94

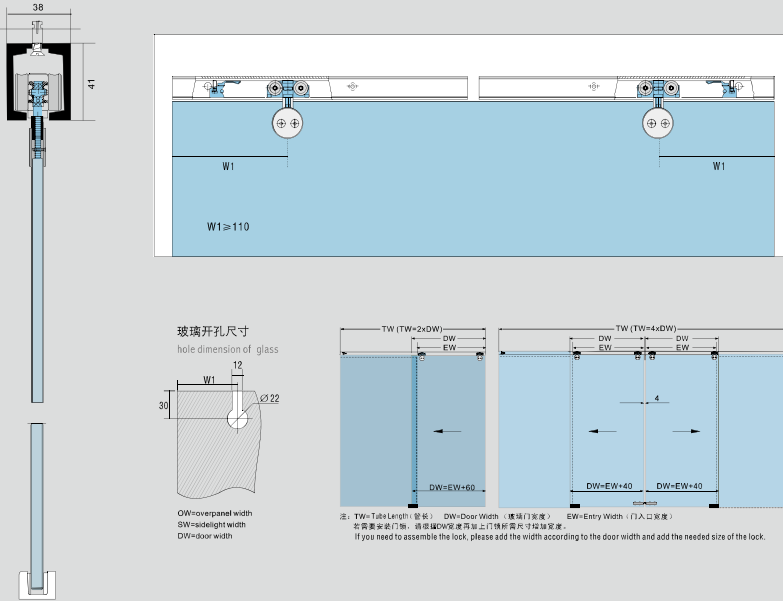

Installation Necessary fitting



WSD-01-1



WSD-01-2



WSD-01-3



WSD-01-4
Guide Track



WSD-01

Wood sliding door



Persistent
with
perfect feeling

BRC-001 Bathroom rod connecting

Material	Thickness
SUS 304 Stainless Steel	10-12mm Tempered glass
Scope of application	Suitable for bathroom glass doors
304	



BRC-002-FE Bathroom rod connecting

Material	Thickness
SUS 304 Stainless Steel	10-12mm Tempered glass
Scope of application	Suitable for bathroom glass doors
304	



BRC-003-F1 Bathroom rod connecting

Material	Thickness
SUS 304 Stainless Steel	10-12mm Tempered glass
Scope of application	Suitable for bathroom glass doors
304	



BRC-004-C Bathroom rod connecting

Material	Thickness
SUS 304 Stainless Steel	10-12mm Tempered glass
Scope of application	Suitable for bathroom glass doors
304	



BRC-003-F2 Bathroom rod connecting

Material	Thickness
SUS 304 Stainless Steel	10-12mm Tempered glass
Scope of application	Suitable for bathroom glass doors
304	



BRC-005-F2 Bathroom rod connecting

Material	Thickness
SUS 304 Stainless Steel	10-12mm Tempered glass
Scope of application	Suitable for bathroom glass doors
304	



EPGC-960 Glass Fixing Bar (Glass-Glass)

Material	
SUS 304 Stainless Steel	
Thickness	
8-12mm Tempered glass	
Finishes available	
Satin Stainless Steel-SSS Polished Stainless Steel-PSS	
304	



EPGC-961 Glass Fixing Bar (Wall-Glass)

Material	
SUS 304 Stainless Steel	
Thickness	
8-12mm Tempered glass	
Finishes available	
Satin Stainless Steel-SSS Polished Stainless Steel-PSS	
304	



EPGC-967 Glass Fixing Bar (Wall-Glass)

Material	
SUS 304 Stainless Steel	
Thickness	
8-12mm Tempered glass	
Finishes available	
Satin Stainless Steel-SSS Polished Stainless Steel-PSS	
304	

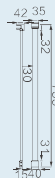

EPGC-968 Glass Fixing Bar (Glass-Glass)

Material	
SUS 304 Stainless Steel	
Thickness	
8-12mm Tempered glass	
Finishes available	
Satin Stainless Steel-SSS Polished Stainless Steel-PSS	
304	

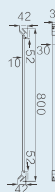

19/25 Rod to Glass connector

800/900 Shower Support Bar Fittings

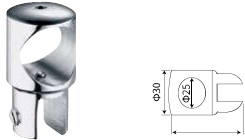

EPGC-902 Rod to Glass connector

Material	Thickness
SUS 304 Stainless Steel	8-12mm Tempered glass
Finishes available	Satin Stainless Steel-SSS Polished Stainless Steel-PSS

304

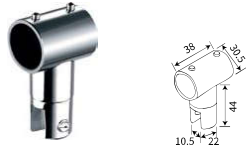

EPGC-002-A Rod to Glass connector

Material	Thickness
SUS 304 Stainless Steel	8-12mm Tempered glass
Finishes available	Satin Stainless Steel-SSS Polished Stainless Steel-PSS

304



EPGC-002-B Rod to Glass connector

Material	Thickness
SUS 304 Stainless Steel	8-12mm Tempered glass
Finishes available	Satin Stainless Steel-SSS Polished Stainless Steel-PSS

304



EPGC-004-F135° Rod to Glass connector

Material	Thickness
SUS 304 Stainless Steel	8-12mm Tempered glass
Finishes available	Satin Stainless Steel-SSS Polished Stainless Steel-PSS

304



EPGC-003 Rod to Glass connector

Material	Thickness
SUS 304 Stainless Steel	8-12mm Tempered glass
Finishes available	Satin Stainless Steel-SSS Polished Stainless Steel-PSS

304

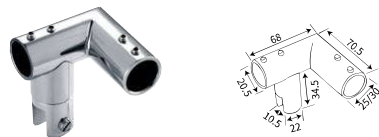

EPGC-004-F90 Rod to Glass connector

Material	Thickness
SUS 304 Stainless Steel	8-12mm Tempered glass
Finishes available	Satin Stainless Steel-SSS Polished Stainless Steel-PSS

304

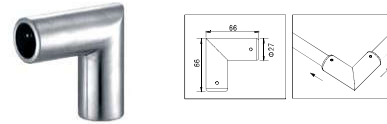

EPGC-005-90° Rod to Glass connector

Material	Thickness
SUS 304 Stainless Steel	8-12mm Tempered glass
Finishes available	Satin Stainless Steel-SSS Polished Stainless Steel-PSS

304

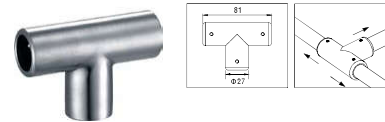

EPGC-007-T Rod to Glass connector

Material	Thickness
SUS 304 Stainless Steel	8-12mm Tempered glass
Finishes available	Satin Stainless Steel-SSS Polished Stainless Steel-PSS

304



EPGC-009 Rod to Glass connector

Material	Thickness
SUS 304 Stainless Steel	8-12mm Tempered glass
Finishes available	Satin Stainless Steel-SSS Polished Stainless Steel-PSS

304



EPGC-011 Rod to Glass connector

Material	Thickness
SUS 304 Stainless Steel	8-12mm Tempered glass
Finishes available	Satin Stainless Steel-SSS Polished Stainless Steel-PSS

304

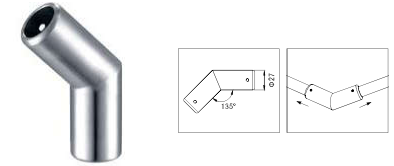

EPGC-006-135° Rod to Glass connector

Material	Thickness
SUS 304 Stainless Steel	8-12mm Tempered glass
Finishes available	Satin Stainless Steel-SSS Polished Stainless Steel-PSS

304



EPGC-008 Rod to Glass connector

Material	Thickness
SUS 304 Stainless Steel	8-12mm Tempered glass
Finishes available	Satin Stainless Steel-SSS Polished Stainless Steel-PSS

304



EPGC-010 Rod to Glass connector

Material	Thickness
SUS 304 Stainless Steel	8-12mm Tempered glass
Finishes available	Satin Stainless Steel-SSS Polished Stainless Steel-PSS

304

BATHROOM ACCESSORIES

E-Pai Bathroom accessories are made of purity brass and sus304,definitude structure and clear line. Matchingwith various installation types,with all complete products and easy to install.

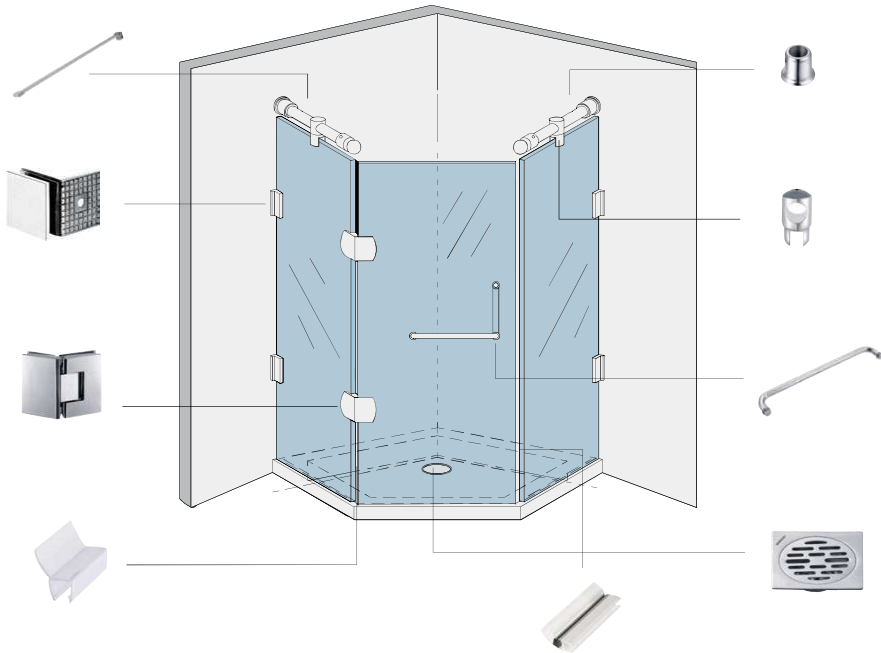

OPERATION SPECIFICATIONS

Operating Maintenance and Attention:

• Notice

For security,pleasebe sure to comply it strictly!
Prohibit laymen unconducted installation,otherwise, it may lead toadverse consequences.

• Forbiddance

A. Do not use solute substances,such as strong cleanser,alcohol,petrol,bananas and acetone,etc;

B. Do not let children or physical inconvenient people to enter the shower room alone,so as to avoid injuries

• Compulsory Execution

A. Make sure use neutral glass cement;

B. The installation for shower room must be carried out strctly inaccordance with the manual instruction. The improper installationmay lead to the missing property injuries for the unstable or evenfalling.

C. Please deal with the unnecessary packaging materials promptly after opening package.The car tonbox and packing belt may lead to stumbling injury.Please do not let children play carton box or packing belt,to avoid any accidents.

D. Shower room offer stained with soapy water,easily slipping.Pleasebe careful to enter and note that high or low location,stumbling.

SHOWER ROOM STYLE

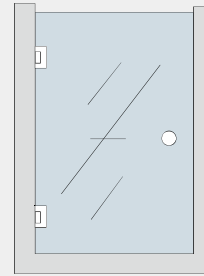

Installation Pattern A

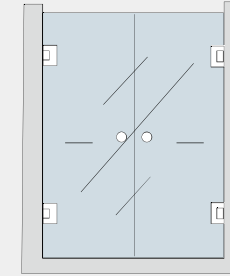

Installation Pattern B

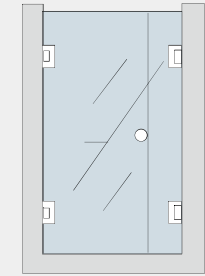

Installation Pattern C

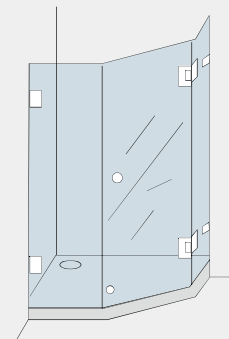

Installation Pattern D

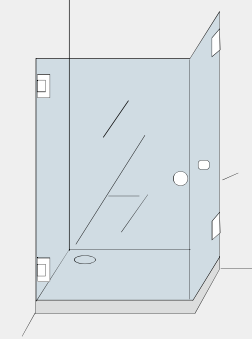

Installation Pattern E

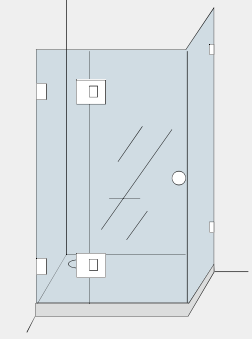

Installation Pattern F

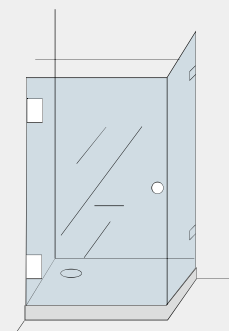

Installation Pattern G

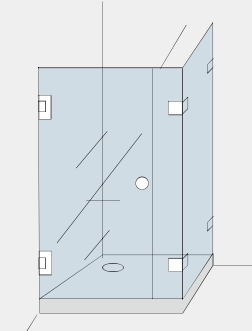

Installation Pattern H

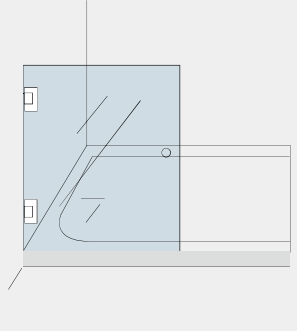

Installation Pattern J



EPGH-3111 Shower Hinge

Material
SUS 304 Stainless Steel

Thickness
8-12mm Tempered glass

Finishes available
Satin Stainless Steel-SSS
Polished Stainless Steel-PSS

304

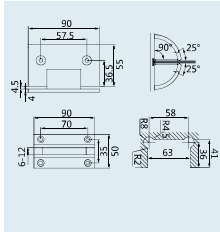

EPGH-3114 Shower Hinge

Material
SUS 304 Stainless Steel

Thickness
8-12mm Tempered glass

Finishes available
Satin Stainless Steel-SSS
Polished Stainless Steel-PSS

304

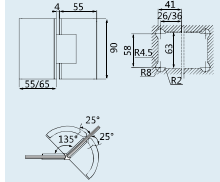

EPGH-3112 Shower Hinge

Material
SUS 304 Stainless Steel

Thickness
8-12mm Tempered glass

Finishes available
Satin Stainless Steel-SSS
Polished Stainless Steel-PSS

304

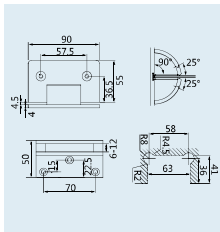

EPGH-3115 Shower Hinge

Material
SUS 304 Stainless Steel

Thickness
8-12mm Tempered glass

Finishes available
Satin Stainless Steel-SSS
Polished Stainless Steel-PSS

304

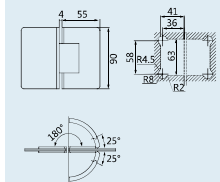

EPGH-3113 Shower Hinge

Material
SUS 304 Stainless Steel

Thickness
8-12mm Tempered glass

Finishes available
Satin Stainless Steel-SSS
Polished Stainless Steel-PSS

304

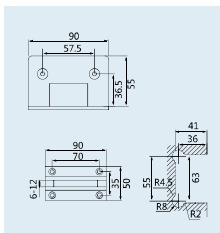

EPGH-3119 Shower Hinge

Material
SUS 304 Stainless Steel

Thickness
8-12mm Tempered glass

Finishes available
Satin Stainless Steel-SSS
Polished Stainless Steel-PSS

304

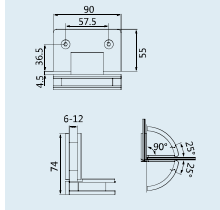

Finish
饰面



镜光

砂光

ORB

金色

US15

玫瑰金

Finish
饰面



镜光

砂光

ORB

金色

US15

玫瑰金



EPGH-2110 Shower Hinge

Material	SUS 304 Stainless Steel
Thickness	8-12mm Tempered glass
Finishes available	Satin Stainless Steel-SSS Polished Stainless Steel-PSS

304

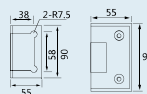

EPGH-2114 Shower Hinge

Material	SUS 304 Stainless Steel
Thickness	8-12mm Tempered glass
Finishes available	Satin Stainless Steel-SSS Polished Stainless Steel-PSS

304

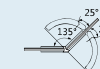
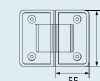

EPGH-2111 Shower Hinge

Material	SUS 304 Stainless Steel
Thickness	8-12mm Tempered glass
Finishes available	Satin Stainless Steel-SSS Polished Stainless Steel-PSS

304

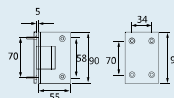

EPGH-2115 Shower Hinge

Material	SUS 304 Stainless Steel
Thickness	8-12mm Tempered glass
Finishes available	Satin Stainless Steel-SSS Polished Stainless Steel-PSS

304

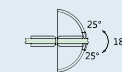
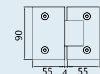

EPGH-2112 Shower Hinge

Material	SUS 304 Stainless Steel
Thickness	8-12mm Tempered glass
Finishes available	Satin Stainless Steel-SSS Polished Stainless Steel-PSS

304

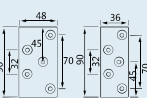
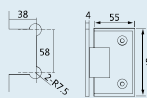

EPGH-2119 Shower Hinge

Material	SUS 304 Stainless Steel
Thickness	8-12mm Tempered glass
Finishes available	Satin Stainless Steel-SSS Polished Stainless Steel-PSS

304

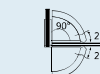
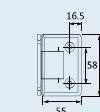

Finish
饰面



镜光

砂光

ORB

金色

US15

玫瑰金

Finish
饰面



镜光

砂光

ORB

金色

US15

玫瑰金



EPGC-01-0P Glass Clamp

Material
SUS 304 Stainless Steel

Thickness
8-12mm Tempered glass

Finishes available

Satin Stainless Steel-SSS
Polished Stainless Steel-PSS

304

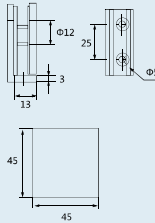

EPGC-01-90 Glass Clamp

Material
SUS 304 Stainless Steel

Thickness
8-12mm Tempered glass

Finishes available

Satin Stainless Steel-SSS
Polished Stainless Steel-PSS

304

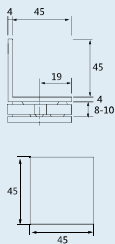

EPGC-01-2135 Glass Clamp

Material
SUS 304 Stainless Steel

Thickness
8-12mm Tempered glass

Finishes available

Satin Stainless Steel-SSS
Polished Stainless Steel-PSS

304

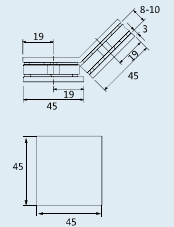

EPGC-01-290 Glass Clamp

Material
SUS 304 Stainless Steel

Thickness
8-12mm Tempered glass

Finishes available

Satin Stainless Steel-SSS
Polished Stainless Steel-PSS

304

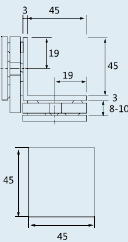

EPGC-01-180 Glass Clamp

Material
SUS 304 Stainless Steel

Thickness
8-12mm Tempered glass

Finishes available

Satin Stainless Steel-SSS
Polished Stainless Steel-PSS

304

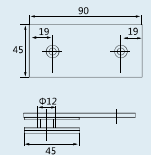

EPGC-01-135 Glass Clamp

Material
SUS 304 Stainless Steel

Thickness
8-12mm Tempered glass

Finishes available

Satin Stainless Steel-SSS
Polished Stainless Steel-PSS

304

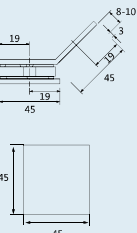

EPGC-01-2180 Glass Clamp

Material
SUS 304 Stainless Steel

Thickness
8-12mm Tempered glass

Finishes available

Satin Stainless Steel-SSS
Polished Stainless Steel-PSS

304

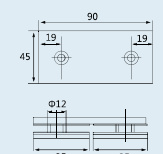



EPGC-03-00 Glass Clamp

Material	SUS 304 Stainless Steel
Thickness	8-10mm Tempered glass
Finishes available	Satin Stainless Steel-SSS Polished Stainless Steel-PSS
304	

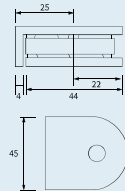

EPGC-03-90 Glass Clamp

Material	SUS 304 Stainless Steel
Thickness	8-10mm Tempered glass
Finishes available	Satin Stainless Steel-SSS Polished Stainless Steel-PSS
304	

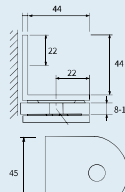

EPGC-03-135 Glass Clamp

Material	SUS 304 Stainless Steel
Thickness	8-10mm Tempered glass
Finishes available	Satin Stainless Steel-SSS Polished Stainless Steel-PSS
304	

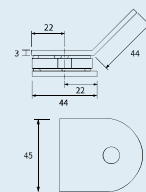

EPGC-03-290 Glass Clamp

Material	SUS 304 Stainless Steel
Thickness	8-10mm Tempered glass
Finishes available	Satin Stainless Steel-SSS Polished Stainless Steel-PSS
304	

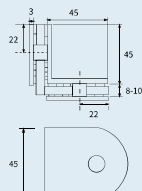

EPGC-03-2135 Glass Clamp

Material	SUS 304 Stainless Steel
Thickness	8-10mm Tempered glass
Finishes available	Satin Stainless Steel-SSS Polished Stainless Steel-PSS
304	

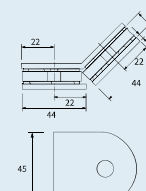

Translucent Sealing Strips

Available for:
All kinds of shower glass door

Function:
Preventing water flowing out from the bathroom glass door

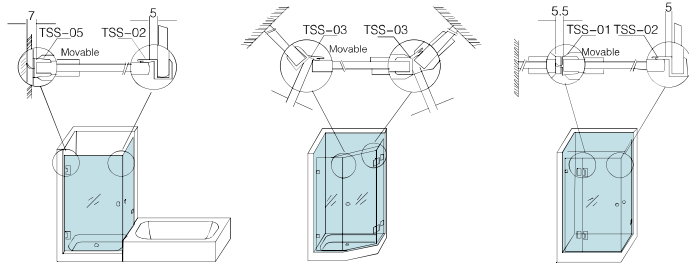

TSS-01 Waterproof seal for shower room glass door
Material: ABS Plastic
Thickness: _____
 Centre seal 90° Transparent with soft lip
 For 8/10/12mm glass

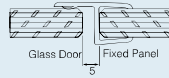

TSS-02 Waterproof seal for shower room glass door
Material: ABS Plastic
Thickness: _____
 Centre seal 90° Transparent with soft lip
 For 8/10/12mm glass

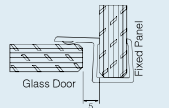

TSS-03 Waterproof seal for shower room glass door
Material: ABS Plastic
Thickness: _____
 Centre seal 135° Transparent with soft lip
 For 8/10/12mm glass

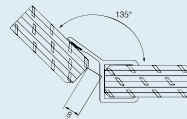

TSS-04 Waterproof seal for shower room glass door
Material: ABS Plastic
Thickness: _____
 Centre seal 180° Transparent with soft lip
 For 8/10/12mm glass

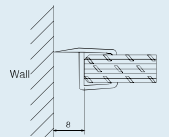

TSS-05 Waterproof seal for shower room glass door
Material: ABS Plastic
Thickness: _____
 Centre seal 90° Transparent with soft lip
 For 8/10/12mm glass

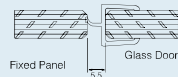

Translucent Sealing Strips

Available for:
All kinds of shower glass door

Function:
Preventing water flowing out from the bathroom glass door

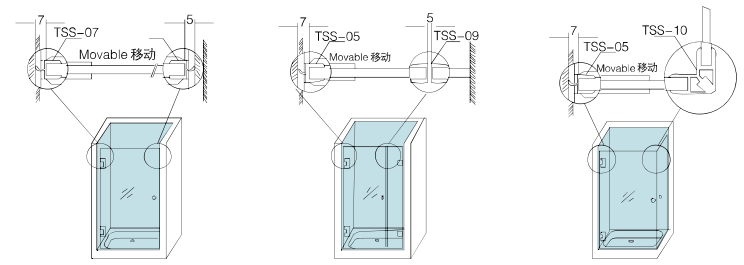

TSS-06 Waterproof seal for shower room glass door
Material: ABS Plastic
Thickness: _____
 Centre seal 90° Transparent with soft lip
 For 8/10/12mm glass

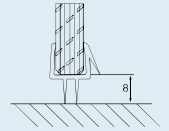

TSS-07 Waterproof seal for shower room glass door
Material: ABS Plastic
Thickness: _____
 Centre seal 90° Transparent with soft lip
 For 8/10/12mm glass

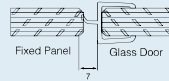

TSS-08 Waterproof seal for shower room glass door
Material: ABS Plastic
Thickness: _____
 Centre seal 135° Transparent with soft lip
 For 8/10/12mm glass

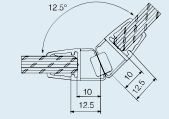

TSS-09 Waterproof seal for shower room glass door
Material: ABS Plastic
Thickness: _____
 Centre seal 180° Transparent with soft lip
 For 8/10/12mm glass

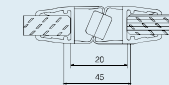

TSS-10 Waterproof seal for shower room glass door
Material: ABS Plastic
Thickness: _____
 Centre seal 90° Transparent with soft lip
 For 8/10/12mm glass

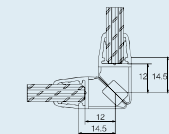

EP BATHROOM

Bathroom hardware

Canopy pai

护派

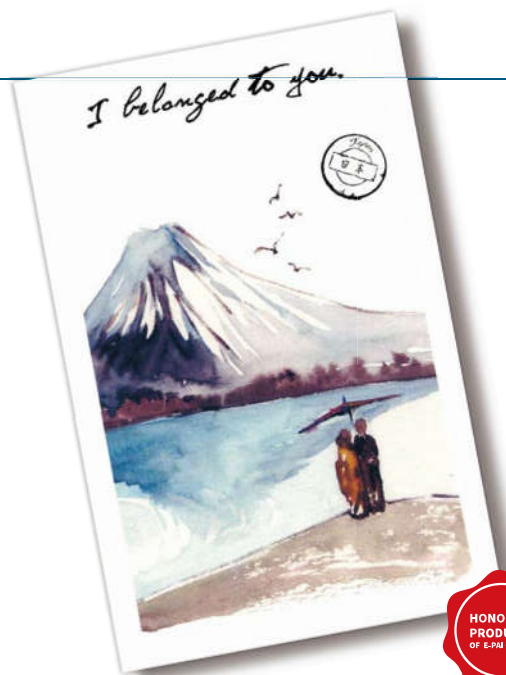

我穿越汹涌的人潮，只为从你的全世界路过。





Beverly pai

Shower Box 67

Installation Necessary fitting

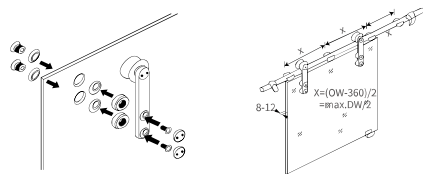

Tubing clip	Entry width	Door width	Tube length
910-1010mm	800-900mm	880-980mm	2038mm
1010-1110mm	900-1000mm	980-1080mm	2238mm
1110-1210mm	1000-1100mm	1080-1180mm	2438mm
1210-1310mm	1100-1200mm	1180-1280mm	2638mm

The distance for clamp fixing for track, wall fixing:

- Weight 80kg: max-distance between the clamps=1/2 the width of the door;
- Weight 80kg-120kg: max-distance between the clamps=1/3 the width of the door;
- Weight 120kg-150kg: max-distance between the clamps=1/4 the width of the door;

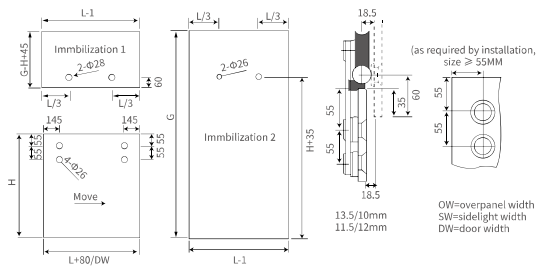

Shower Box 13

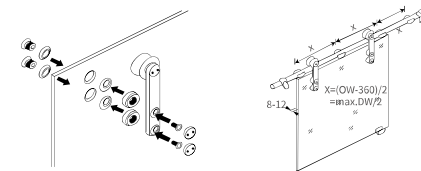

Tubing clip	Entry width	Door width	Tube length
910-1010mm	800-900mm	880-980mm	2038mm
1010-1110mm	900-1000mm	980-1080mm	2238mm
1110-1210mm	1000-1100mm	1080-1180mm	2438mm
1210-1310mm	1100-1200mm	1180-1280mm	2638mm

The distance for clamp fixing for track, wall fixing:

- Weight 80kg: max-distance between the clamps=1/2 the width of the door;
- Weight 80kg-120kg: max-distance between the clamps=1/3 the width of the door;
- Weight 120kg-150kg: max-distance between the clamps=1/4 the width of the door;

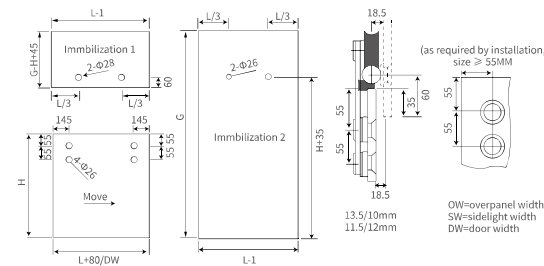

Blythe pai

Necessary fitting Installation



Shower Box 67

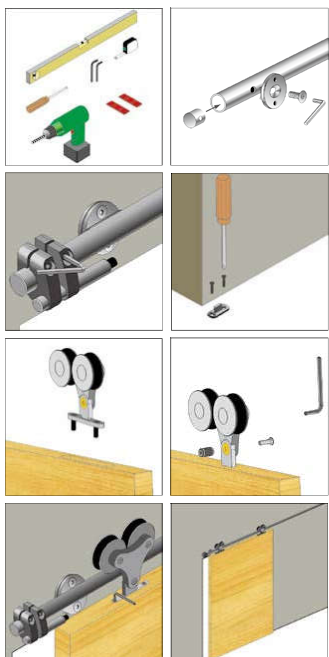

Modle-41-Woodendoor

Installation Necessary fitting



WSD-02-Single
Wood sliding door

WSD-02-Double
Wood sliding door



Shower Box 28

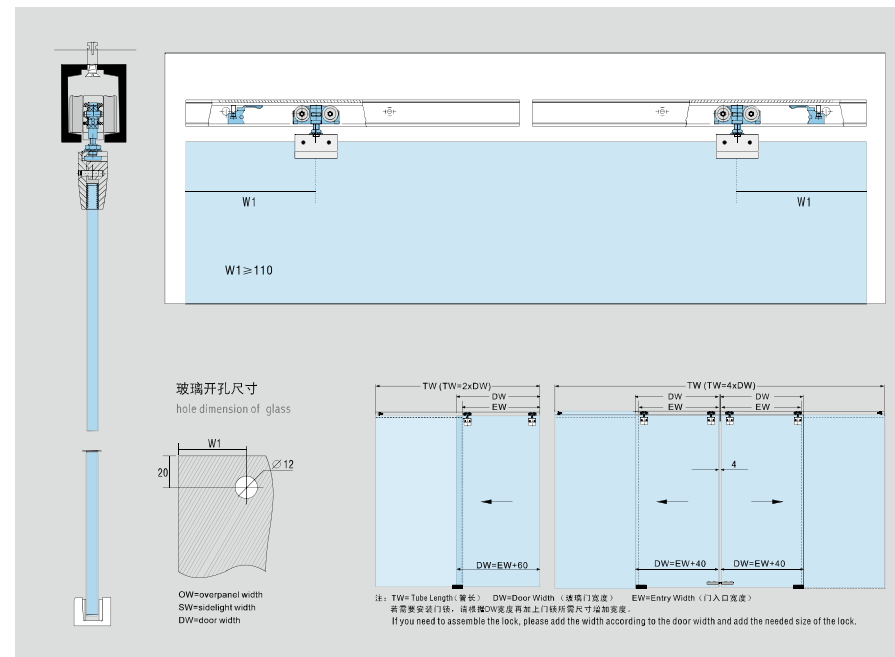

Modle-91

Necessary fitting Installation



WSD-01
Wood sliding door

WSD-01-1

WSD-01-2

WSD-01-3

WSD-01-4
Guide Track

Swing door mode 1s

Material	Thickness
SUS 304 Stainless Steel	10-12mm Tempered glass
Scope of application	Suitable for bathroom glass doors
304	

Connecting Pivot

Pivot pole with single point fixings and pivot bearing for intermediate tube
 Maximum load : 100kg
 For glass 10-12mm
 Can offer various of floor spring connections

With the advanced technology and innovated mode, the professional glass connecting system can make use of therays more effectively, construct faster, adopt the material for environment protection and provide the designer with essential space for design and invention. Each series of connecting product have perfect systemic structure design, which can save installation material, installation charge and shorten the construction period. We study the project of glass structure with designers to consummate our product and unify the product with the building. Just about the close cooperation with the designers, we recommend a series of application products.

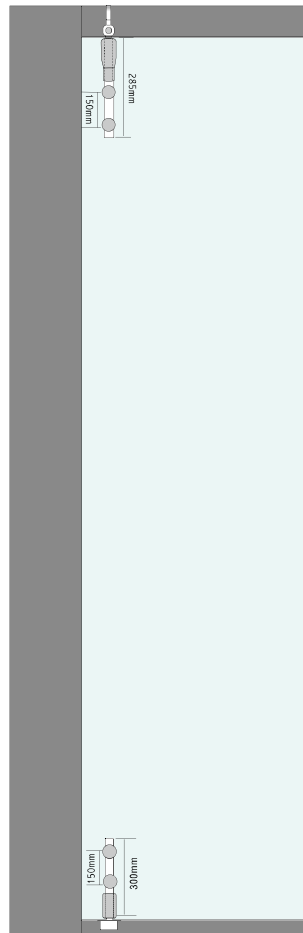
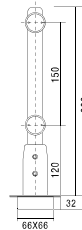
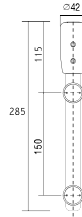

GH-11

Material	Thickness
SUS 304 Stainless Steel	10-12mm Tempered glass
Scope of application	Suitable for bathroom glass doors
304	

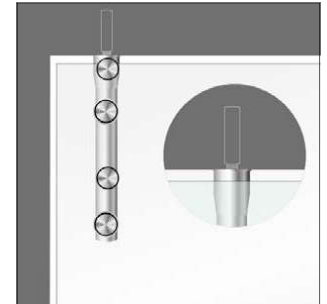

GH-12 Upper-wall pivot

Material	Thickness
SUS 304 Stainless Steel	10-12mm Tempered glass
Scope of application	Suitable for bathroom glass doors
304	



GH-13 Upper-wall pivot

Material	Thickness
SUS 304 Stainless Steel	10-12mm Tempered glass
Scope of application	Suitable for bathroom glass doors
304	



EP GRAB BAR

Disabled Grab Bar

CARE pai

爱派

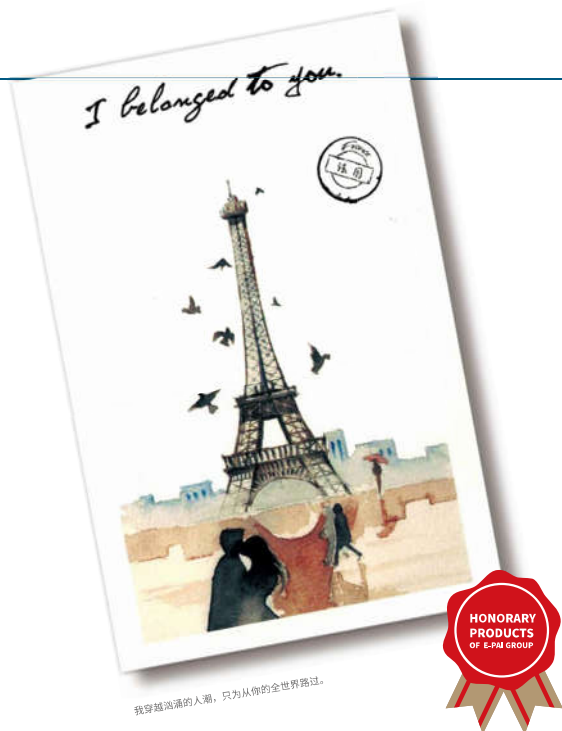

我穿越汹涌的人潮，只为从你的全世界路过。



EPAI GRAB BAR



Care, care, care for small things

Full production of first-class products conforms to ISO9001 product quality system management and control

(EPAI Grab Bar) Anti slip strip is added to the product to create a sense of security for the elderly and the disabled, as well as for those who suffer from menstrual pain and are inconvenient to get the proper sense of security in these places. Take full care of people in need.



QUALITY PREMIUM

Someone who improves your sense of security.
E-pai's traditional high demand quality control thinking,
Combined with strict iso9001:2016 (2015) quality control.

DISABLED GRAB BAR

Disabled folding handicap toilet grab bar



EPGB-001 Folding Grab bar 131

Material	Thickness
SUS 304 Stainless Steel	580x220mm
	OD:32mm

304

EPGB-002 Folding Grab bar 134

Material	Thickness
SUS 304 Stainless Steel	580x220mm
	OD:32mm

304

Schematic diagram

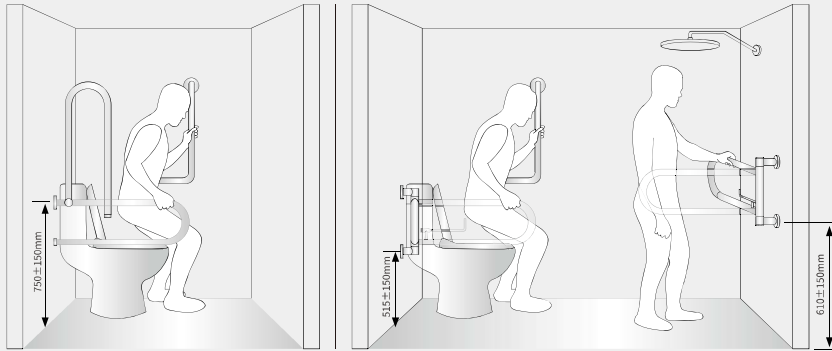

INSTALLATION

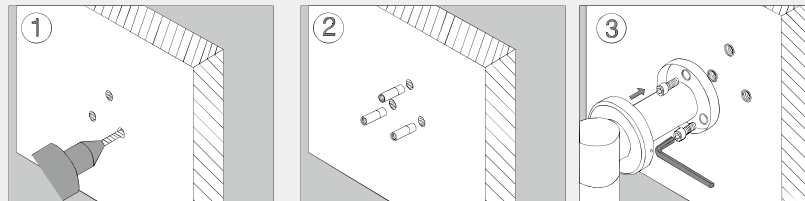

1. Locate the installation location as required and drill the bit with a 2cm (6mm) bit. *The center should be straight, and once stuck, it will become very dense.

2. Put the transparent pads in a hole and tighten all pads.

3. Tighten the fastening bolt to fix the workpiece on the bushing. Tighten the trim cover with an Allen key.

Safety Grab Bar



EPGB-25-12" Grab Bar 12"

Material	Thickness
SUS 304 Stainless Steel	300mm
	OD:25mm

304



EPGB-25-14" Grab Bar 14"

Material	Thickness
SUS 304 Stainless Steel	360mm
	OD:25mm

304



EPGB-25-18" Grab Bar 18"

Material	Thickness
SUS 304 Stainless Steel	450mm
	OD:25mm



EPGB-25-24" Grab Bar 24"

Material	Thickness
SUS 304 Stainless Steel	600mm
	OD:25mm

304



EPGB-25-28" Grab Bar 28"

Material	Thickness
SUS 304 Stainless Steel	680mm
	OD:25mm



EPGB-25-32" Grab Bar 32"

Material	Thickness
SUS 304 Stainless Steel	900mm
	OD:25mm



EPGB-32-18" Grab Bar 18"
Material **Thickness**
 SUS 304 Stainless Steel 450mm
 OD:32mm
 304



EPGB-32-24" Grab Bar 24"
Material **Thickness**
 SUS 304 Stainless Steel 600mm
 OD:32mm
 304



EPGB-32-31" Grab Bar 31"
Material **Thickness**
 SUS 304 Stainless Steel 1200mm
 OD:32mm
 304



EPGB-825-2-2 Grab bar 8"x8"
Material **Thickness**
 SUS 304 Stainless Steel 200x200mm
 Satin 135° OD 25mm
 304



EPGB-825-3-3 Grab bar 12"x12"
Material **Thickness**
 SUS 304 Stainless Steel 300x300mm
 Satin 135° OD 32mm
 304



EPGB-L32-34 Grab bar 12"x18"
Material **Thickness**
 SUS 304 Stainless Steel 300x450mm
 Satin 90° OD 32mm
 304



EPGB-L32-36 Grab bar 12"x24"
Material **Thickness**
 SUS 304 Stainless Steel 300x600mm
 Satin 90° OD 32mm
 304



EPGB-825-2-2 Grab bar 10"x10"
Material **Thickness**
 SUS 304 Stainless Steel 200x200mm
 Polished 135° OD 32mm
 304



EPGB-825-3-4 Grab bar 15"
Material **Thickness**
 SUS 304 Stainless Steel 300x400mm
 Polished 135° OD 32mm
 304



EPGB-L32-35 Grab bar 19"
Material **Thickness**
 SUS 304 Stainless Steel 300x480mm
 Polished 90° OD 32mm
 304



EPGB-832-35B Safety Grab Bar
Material SUS 304 Stainless Steel **Thickness** 300x800mm
 135° OD 25mm
 304



EPGB-L32-66BR Safety Grab Bar
Material SUS 304 Stainless Steel **Thickness** 600x600mm
 90° OD 32mm
 304



EPGB-832-34 Safety Grab Bar
Material SUS 304 Stainless Steel **Thickness** 300x400mm
 135° OD 32mm
 304



EPGB-L32-6-6BL Safety Grab Bar
Material SUS 304 Stainless Steel **Thickness** 600x600mm
 90° OD 32mm
 304



EPGB-LL32-6-6B Safety Grab Bar
Material SUS 304 Stainless Steel **Thickness** 600x600mm
 90° OD 32mm
 304

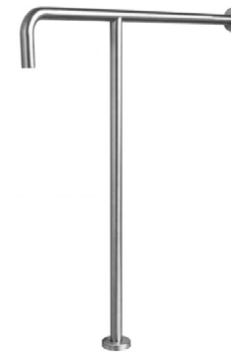

GB-T25-7-7 Safety Grab Bar
Material SUS 304 Stainless Steel **Thickness** 700x700mm
 OD:25mm
 304

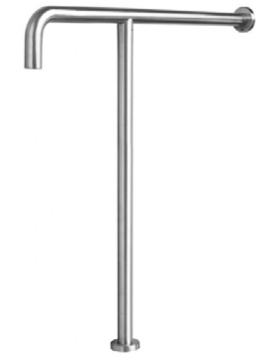

GB-T32-7-7 Safety Grab Bar
Material SUS 304 Stainless Steel **Thickness** 700x700mm
 OD:32mm
 304

COORDINATING FINISH:
coordinates with today's popular kitchen
appliances and accessories

SUPPORTIVE DESIGN
Bathroom grab bar supports up to 500 lbs when
installed in a stug or when using SecureMounts
(not included)

SAFE AND SECURE
SecureMount design for easy, secure installation
(sold separately)

PEACE-OF-MIND
Designed for hassle-free installation

BUILT TO LAST
Backed by E-pai's Limited Warranty
Stainless finish delivers a lightly brushed warm
gray metallic look Concealed screw

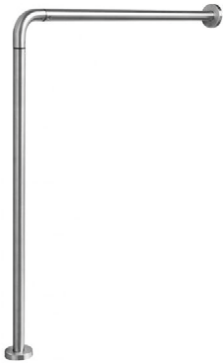

GB-72-25

Material
SUS 304 Stainless Steel

Thickness
700x750mm
OD:25mm

304



GB-72-32

Material
SUS 304 Stainless Steel

Thickness
700x750mm
OD:32mm

304



GB-U7-32

Material
SUS 304 Stainless Steel

Thickness
800x700mm
OD:32mm

304

INSTALLATION PHASE, USING SCENARIO APPLICATION MODE

Use of different floors

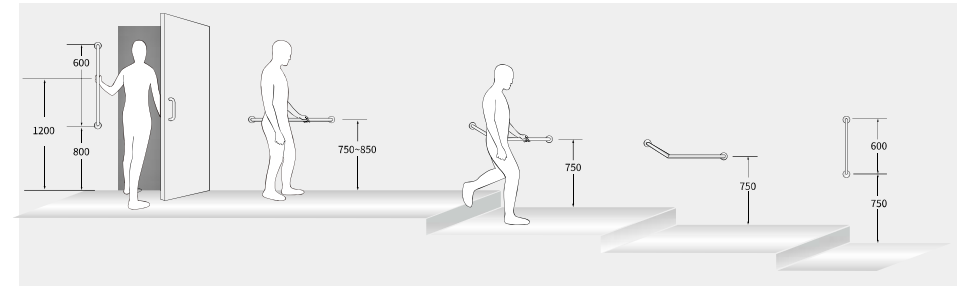

Use scene of bathroom



Coordinated finishes: Stainless steel finishes
harmonize with today's popular kitchen
appliances and accessories

Support design: When mounted on a door post or
using a safety bracket (not included), the bathroom
armrest supports up to 500 pounds

Safe and reliable: SecureMount is designed for safe
installation (sold separately)

Peace of mind: Designed for barrier-free installation

Durable: Supported by E-pai limited warranty
Stainless steel finish provides a light brushed warm
gray metal look Concealed screw

PEACE-OF-MIND:

Designed for hassle-free installation

SUPPORTIVE DESIGN:

Bathroom grab bar supports up to 500 lbs when installed in a stug or
when using SecureMounts (not included)

EP GLASS CANOPY

Canopy hardware

Canopy pai

护派



我穿越汹涌的人潮，只为从你的全世界路过。





Canpy-13 Glass Canopy Fitting

Material
SUS 304 Stainless Steel

Thickness
8-10mm Tempered glass

Finishes available
Satin Stainless Steel-SSS
Polished Stainless Steel-PSS

304

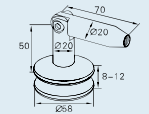

Canpy-14 Glass Canopy Fitting

Material
SUS 304 Stainless Steel

Thickness
12mm Tempered glass

Scope of application
Suitable for side hinge door of office building, deluxe chamber and so on

304

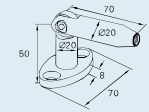

Canpy-15 Glass Canopy Fitting

Material
SUS 304 Stainless Steel

Thickness
8-10mm Tempered glass

Finishes available
Satin Stainless Steel-SSS
Polished Stainless Steel-PSS

304

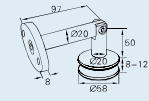

Installation case diagram:

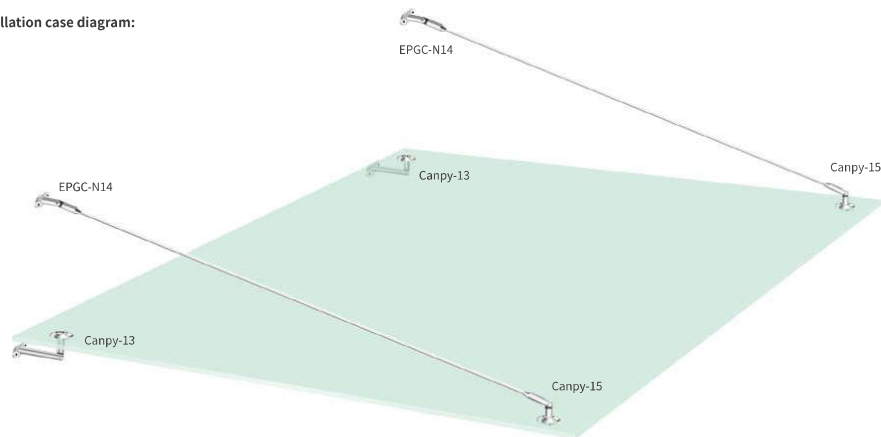

EP GLASS FITTING

Adjustable wall glass fitting

Solid pai

团派

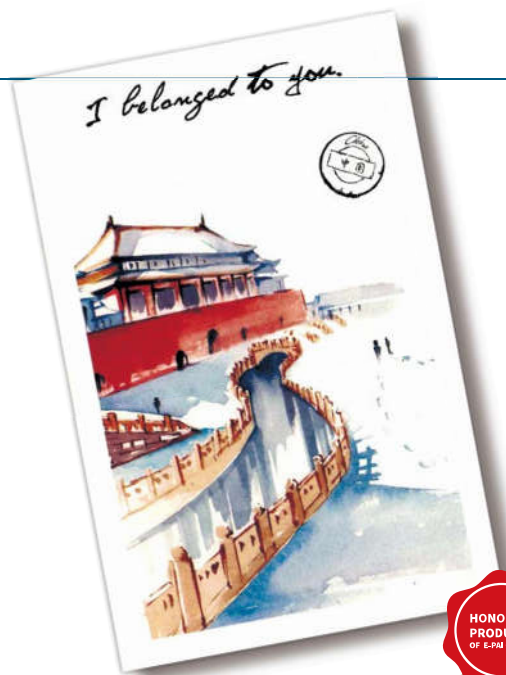

我穿越汹涌的人潮，只为从你的全世界路过。



INSTALLATION CASE DIAGRAM:

Glass preparation: For glass/glass corner connectors for 10mm or 12mm tempered glass.

Planview

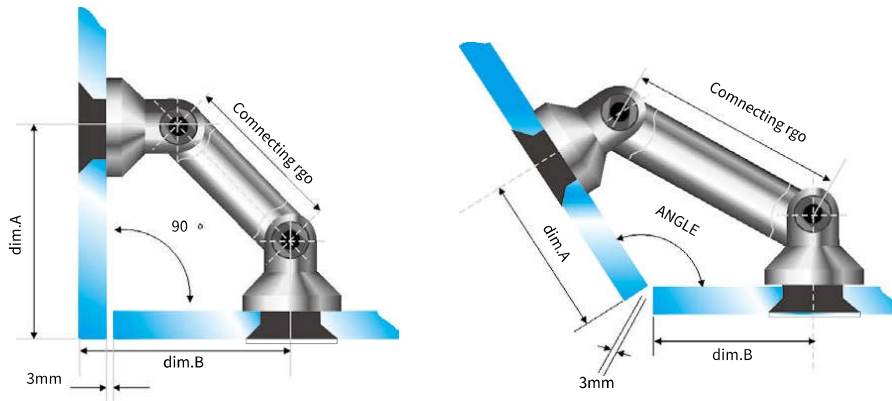

Two kinds connecting for glass hole:

Use: two kinds options of glasses connection, mainly for clamping glasses.

Countersunkhole=CS(Countersunk hole)

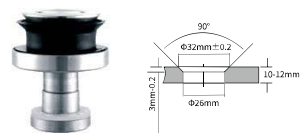

Countersunk holes from the front side

Flat hole=STD(Standard hole)

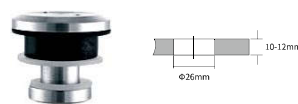

Flat holes from the front side

Connecting rod:



Angle	Length connecting rod and in mm			
	52.5	60	82	103
90°	A/B	A/B	A/B	A/B
95°	75.6	81	96.5	111.3
100°	60.2	65.3	80.5	94.5
105°	56.7	61.6	75.9	89.5
110°	53.4	58.2	72.1	85.3
115°	50.5	55.1	68.5	81.3
120°	47.8	51.8	65.3	77.7
125°	45.3	49.5	62.3	74.4
130°	42.8	47.1	59.5	71.4
135°	40.7	44.9	57	68.6
180°	38.7	42.8	54.7	66
	24.7	28.5	39.5	50

Components and assembly of the wall fixing

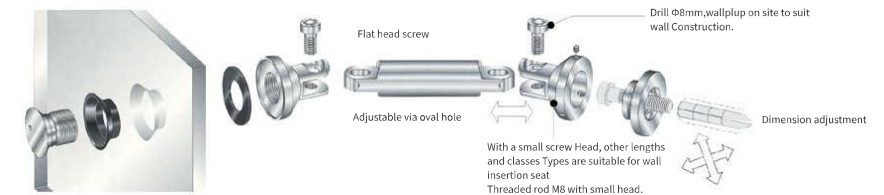

For glass/glass corner connectors for 10mm or 12mm tempered glass.

HB-180A-4 Adjustable pig noise spanner

Material
SUS 304 Stainless Steel

304



Use: the tool for installation and backout glass connection



EPGF-GG-01 Adjustable Wall Glass Fitting

Material	
SUS 304 Stainless Steel	
Thickness	
8-12mm Tempered glass	
Finishes available	Satin Stainless Steel-SSS Polished Stainless Steel-PSS
304	



EPGF-GW-03 Adjustable Wall Glass Fitting

Material	
SUS 304 Stainless Steel	
Thickness	
8-12mm Tempered glass	
Finishes available	Satin Stainless Steel-SSS Polished Stainless Steel-PSS
304	



EPGF-GW-01 Adjustable Wall Glass Fitting

Material	
SUS 304 Stainless Steel	
Thickness	
8-12mm Tempered glass	
Finishes available	Satin Stainless Steel-SSS Polished Stainless Steel-PSS
304	

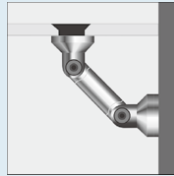

EPGF-GG-02 Adjustable Wall Glass Fitting

Material	
SUS 304 Stainless Steel	
Thickness	
8-12mm Tempered glass	
Finishes available	Satin Stainless Steel-SSS Polished Stainless Steel-PSS
304	



EPGF-GW-02 Adjustable Wall Glass Fitting

Material	
SUS 304 Stainless Steel	
Thickness	
8-12mm Tempered glass	
Finishes available	Satin Stainless Steel-SSS Polished Stainless Steel-PSS
304	

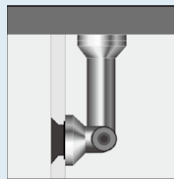

EPGF-GG-01-DOUBLE Adjustable Wall Glass Fitting

Material	
SUS 304 Stainless Steel	
Thickness	
8-12mm Tempered glass	
Finishes available	Satin Stainless Steel-SSS Polished Stainless Steel-PSS
304	

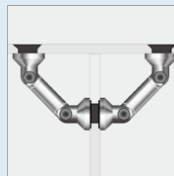



EPGF-GF-01 Adjustable Wall Glass Fitting

Material	
SUS 304 Stainless Steel	
Thickness	
8-12mm Tempered glass	
Finishes available	Satin Stainless Steel-SSS Polished Stainless Steel-PSS
304	



EPGF-GF-01-DOUBLE Adjustable Wall Glass Fitting

Material	
SUS 304 Stainless Steel	
Thickness	
8-12mm Tempered glass	
Finishes available	Satin Stainless Steel-SSS Polished Stainless Steel-PSS
304	

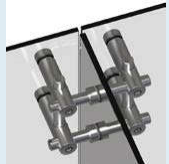

EPGF-GP-01 Adjustable Wall Glass Fitting

Material	
SUS 304 Stainless Steel	
Thickness	
8-12mm Tempered glass	
Finishes available	Satin Stainless Steel-SSS Polished Stainless Steel-PSS
304	



EPGF-GP-02 Adjustable Wall Glass Fitting

Material	
SUS 304 Stainless Steel	
Thickness	
8-12mm Tempered glass	
Finishes available	Satin Stainless Steel-SSS Polished Stainless Steel-PSS
304	

