

JINGKE  
Lighting

Light Up The Future

# CATALOG

2025-2026 LED LUMINAIRES

JIANGXI JINGKE ELECTRONICS CO., LTD

Address: Meidi Road, Guixi Industrial Zone, Guixi City,  
Jiangxi Province, China.

Zip code:335400

Foshan Office: Star Tower , No. 6 Fenjiang Road, Foshan  
City, China, Zip code: 528000

+86 13703061372  
+86 13556051000

annawong\_r1@163.com  
benny\_r1@163.com

<http://jxjkdz.com>



Since 2013



JINGKE was founded in 2013, it's a global comprehensive lighting manufacturer, credible supplier and service provider. We have our R&D team and production team with 400 employees, export to more than 80 countries in the world.

The company has its robust sales and service team. Through continuous innovation and sustainable development, JINKE strives to be a trusted OEM/ODM partner for all customers.







# CONTENT



Down light 01~14

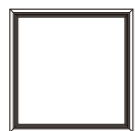

Back-lit Panel 14~18



Ceiling Light 19~28



Battens 29~32

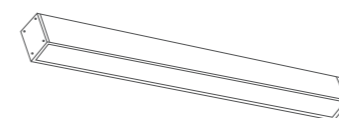

Linear Light 33~36



Flood Light 37~42

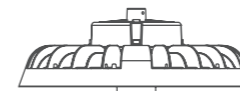

High Bay 43~44



Solar Light 45~50

### Recessed Plastic

#### FEATURES:

- LED High brightness chip
- High quality materials
- Saving energy



1CCT/3CCT Available

2700K 4000K 6500K

Model	Product size	Cut out size	Power	Lumen	Voltage	PF	DF	CRI	CCT (K)	IP	Material
JY-2.5"-3W-R-Re	Φ 100*26	Φ 75-86	3W	240Lm	AC220-240V	0.5	/	80	3000/4000/6500K	IP20	plastic
JY-3"-6W-R-Re	Φ 120*26	Φ 95-106	6W	490Lm	AC220-240V	0.5	0.7	80	3000/4000/6500K	IP20	plastic
JY-4"-9W-R-Re	Φ 145*26	Φ 115-129	9W	820Lm	AC220-240V	0.5	0.7	80	3000/4000/6500K	IP20	plastic
JY-6"-12W-R-R	Φ 175*26	Φ 145-160	12W	1155Lm	AC220-240V	0.5	0.7	80	3000/4000/6500K	IP20	plastic
JY-8"-18W-R-Re	Φ 225*28	Φ 189-207	18W	1830Lm	AC220-240V	0.5	0.7	80	3000/4000/6500K	IP20	plastic
JY-12"-24W-R-Re	Φ 295*28	Φ 265-279	24W	2490Lm	AC220-240V	0.7	0.7	80	3000/4000/6500K	IP20	plastic
JY-3"-6W-S-Re	120*120*26	95-106	6W	490Lm	AC220-240V	0.5	0.7	80	3000/4000/6500K	IP20	plastic
JY-4"-9W-S-Re	145*145*26	109-127	9W	820Lm	AC220-240V	0.5	0.7	80	3000/4000/6500K	IP20	plastic
JY-6"-12W-S-Re	175*175*26	140-157	12W	1155Lm	AC220-240V	0.5	0.7	80	3000/4000/6500K	IP20	plastic
JY-8"-18W-S-Re	225*225*28	190-207	18W	1850Lm	AC220-240V	0.5	0.7	80	3000/4000/6500K	IP20	plastic
JY-12"-24W-S-Re	295*295*28	265-280	24W	2500Lm	AC220-240V	0.7	0.7	80	3000/4000/6500K	IP20	plastic

### Surface Plastic

#### FEATURES :

- LED High brightness chip
- High quality materials
- Saving energy



1CCT/3CCT Available

2700K 4000K 6500K

Model	Product size	Power	Lumen	Voltage	PF	DF	CRI	CCT (K)	IP	Material
JY-4"-9W-R-Sur	Φ 151*36	9W	820Lm	AC220-240V	0.5	0.7	80	3000/4000/6500K	IP20	plastic
JY-6"-12W-R-Sur	Φ 176*36	12W	1155Lm	AC220-240V	0.5	0.7	80	3000/4000/6500K	IP20	plastic
JY-8"-18W-R-Sur	Φ 226*36	18W	1830Lm	AC220-240V	0.5	0.7	80	3000/4000/6500K	IP20	plastic
JY-12"-24W-R-Sur	Φ 296*36	24W	2490Lm	AC220-240V	0.7	0.7	80	3000/4000/6500K	IP20	plastic
JY-4"-9W-S-Sur	151*151*36	9W	820Lm	AC220-240V	0.5	0.7	80	3000/4000/6500K	IP20	plastic
JY-6"-12W-S-Sur	176*176*36	12W	1155Lm	AC220-240V	0.5	0.7	80	3000/4000/6500K	IP20	plastic
JY-8"-18W-S-Sur	226*226*36	18W	1830Lm	AC220-240V	0.5	0.7	80	3000/4000/6500K	IP20	plastic
JY-12"-24W-S-Su	296*296*36	24W	2490Lm	AC220-240V	0.7	0.7	80	3000/4000/6500K	IP20	plastic

Trimless Surface Mount

FEATURES

- LED High brightness chip
- High quality materials
- Saving energy



Model	Product size	Power(W)	Lumen output	Voltage	PF	CRI	CCT (K)	IP	Beam Angle	Material
JY-DL-20	Φ 170*40	20W	2200	AC180-280V	0.5	80	3000/4000/6500K	IP20	120°	Alu+PP
JY-DL-30	Φ 225*40	30W	3300	AC180-280V	0.5	80	3000/4000/6500K	IP20	120°	Alu+PP



IP20, RECESSED

Model	Product size (mm)	Cut hole	Power(W)	Lumen	Efficacy	Voltage	PF	CRI	CCT (K)	Dim	Beam Angle	Warranty	Material
JY-9W-R-RE-A	Φ 100*33	Φ 70-75	9W	720	80	AC170-265V	0.5	80	3000/4000/6500K	NO	120°	2Years	Die ALU+PS
JY-12W-R-RE-A	Φ 120*33	Φ 90-100	12W	960	80	AC170-265V	0.5	80	3000/4000/6500K	NO	120°	2Years	Die ALU+PS
JY-15W-R-RE-A	Φ 145*34	Φ 115-125	15W	1200	80	AC170-265V	0.5	80	3000/4000/6500K	NO	120°	2Years	Die ALU+PS
JY-20W-R-RE-A	Φ 165*34	Φ 135-145	20W	1800	80	AC170-265V	0.5	80	3000/4000/6500K	NO	120°	2Years	Die ALU+PS
JY-25W-R-RE-A	Φ 180*35	Φ 150-165	25W	2000	80	AC170-265V	0.9	80	3000/4000/6500K	NO	120°	2Years	Die ALU+PS
JY-36W-R-RE-A	Φ 230*36	Φ 190-200	36W	2880	80	AC170-265V	0.9	80	3000/4000/6500K	NO	120°	2Years	Die ALU+PS

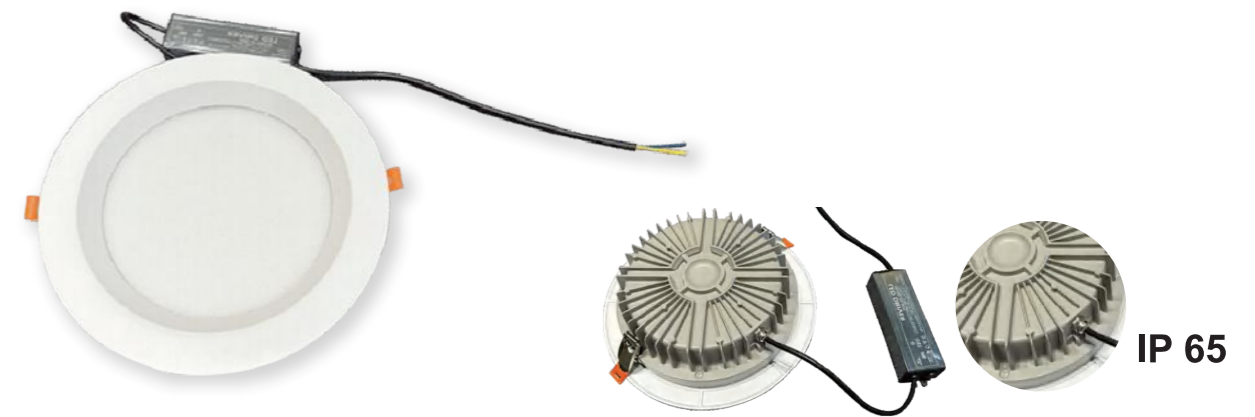

IP65, RECESSED

Model	Product size (mm)	Cut hole	Power(W)	Lumen	Efficacy	Voltage	PF	CRI	CCT (K)	Dim	Beam Angle	Warranty	Material
JY-7W-R-RE-B	Φ 95*44	Φ 75mm	7W	560	80	AC220-240V	0.5	80	3000/4000/6500K	NO	120°	3Years	Die ALU+PS
JY-12W-R-RE-B	Φ 140*52	Φ 115mm	18W	1440	80	AC220-240V	0.5	80	3000/4000/6500K	NO	120°	3Years	Die ALU+PS
JY-18W-R-RE-B	Φ 140*52	Φ 115mm	20W	1600	80	AC220-240V	0.5	80	3000/4000/6500K	NO	120°	3Years	Die ALU+PS
JY-25W-R-RE-B	Φ 165*54	Φ 145mm	25W	2000	80	AC220-240V	0.5	80	3000/4000/6500K	NO	120°	3Years	Die ALU+PS
JY-30W-R-RE-B	Φ 195*62	Φ 165mm	30W	2400	80	AC220-240V	0.9	80	3000/4000/6500K	NO	120°	3Years	Die ALU+PS
JY-42W-R-RE-B	Φ 230*62	Φ 195mm	40W	3200	80	AC220-240V	0.9	80	3000/4000/6500K	NO	120°	3Years	Die ALU+PS
JY-42W-R-RE-B	Φ 280*70	Φ 220mm	50W	4000	80	AC220-240V	0.9	80	3000/4000/6500K	NO	120°	3Years	Die ALU+PS

## FEATURES

- Edgelite, Slim in size,
- Diecast Alu. materials, PS diffuser
- Lifetime 25,000hrs



### Recessed



### Surface



### 1CCT/3CCT Available

Model	Voltage	Power(W)	CCT	PF	Lumen output (lm)	CRI	Product size	Hole size	Beam Angle	IP
JY-R3	AC220-240V	3W	2700-6500K	/	120-135lm	80	Φ85	Φ75	120°	IP20
JY-R6	AC220-240V	6W	2700-6500K	0.7	330-360lm	80	Φ120	Φ105	120°	IP20
JY-R9	AC220-240V	9W	2700-6500K	0.7	495-540lm	80	Φ145	Φ130	120°	IP20
JY-R12	AC220-240V	12W	2700-6500K	0.7	900-960lm	80	Φ170	Φ155	120°	IP20
JY-R18	AC220-240V	18W	2700-6500K	0.7	1350-1440lm	80	Φ220	Φ205	120°	IP20
JY-R24	AC220-240V	24W	2700-6500K	0.7	1800-1920lm	80	Φ292	Φ280	120°	IP20
JY-S3	AC220-240V	3W	2700-6500K	/	120-135lm	80	85*85	75*75	120°	IP20
JY-S6	AC220-240V	6W	2700-6500K	0.7	330-360lm	80	120*120	105*105	120°	IP20
JY-S9	AC220-240V	9W	2700-6500K	0.7	495-540lm	80	145*145	130*130	120°	IP20
JY-S12	AC220-240V	12W	2700-6500K	0.7	900-960lm	80	170*70	155*155	120°	IP20
JY-S18	AC220-240V	18W	2700-6500K	0.7	1350-1440lm	80	220*220	200*200	120°	IP20
JY-S24	AC220-240V	24W	2700-6500K	0.7	1800-1920lm	80	290*290	275*275	120°	IP20

### 1CCT/3CCT Available

Model	Voltage	Power(W)	CCT	PF	Lumen output (lm)	CRI	Product size	Height	Beam Angle	IP
JY-R6	AC220-240V	6W	2700-6500K	0.7	330-360lm	80	Φ112	28mm	120°	IP20
JY-R12	AC220-240V	12W	2700-6500K	0.7	900-960lm	80	Φ160	28mm	120°	IP20
JY-R18	AC220-240V	18W	2700-6500K	0.7	1350-1440lm	80	Φ210	28mm	120°	IP20
JY-R24	AC220-240V	24W	2700-6500K	0.7	1800-1920lm	80	Φ282	28mm	120°	IP20
JY-S6	AC220-240V	6W	2700-6500K	0.7	330-360lm	80	112.112	28mm	120°	IP20
JY-S12	AC220-240V	12W	2700-6500K	0.7	900-960lm	80	160*160	28mm	120°	IP20
JY-S18	AC220-240V	18W	2700-6500K	0.7	1350-1440lm	80	210*210	28mm	120°	IP20
JY-S24	AC220-240V	24W	2700-6500K	0.7	1800-1920lm	80	282*282	28mm	120°	IP20

FEATURES :

- COB chip,external driver
- Diecast Alu. body for excellcent heat dissipation
- Lifetime 25,000hrs

Recessed CB



Model	Voltage	Power(W)	Lumen output(lm)	CRI	PF	Beam Angle	Led model	Product size	Cut out size	Work term	Material	IP
JY-Recessed-7	AC100-240V	7W	630lm	≥80	0.5	60°	COB	2.5" 95MM	Φ75	-20~50℃	ALU+GLASS	IP20
JY-Recessed-10	AC100-240V	10W	900lm	≥80	0.5	90°	COB	4" 125MM	Φ100	-20~55℃	ALU+GLASS	IP20
JY-Recessed-20	AC100-240V	20W	1350lm	≥80	0.5	90°	COB	5" 160MM	Φ140	-20~55℃	ALU+GLASS	IP20
JY-Recessed-30	AC100-240V	30W	2700lm	≥80	0.5	90°	COB	8" 220MM	Φ200	-20~55℃	ALU+GLASS	IP20

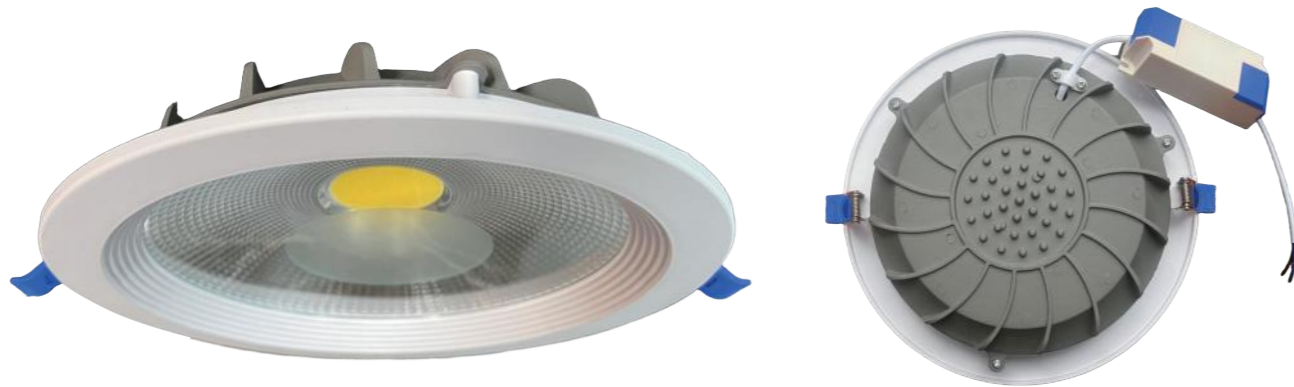

Model	Voltage	Power(W)	Lumen output(lm)	CRI	PF	Beam Angle	Led model	Product size	Cut out size	Material	IP
JY-COB-DL-7W	AC180-280V	7W	560lm	≥80	0.5	90°	COB	2.5" 90MM	Φ75	ALU+PP+GLASS	IP20
JY-COB-DL-10W	AC180-280V	10W	720lm	≥80	0.5	90°	COB	4" 120MM	Φ100	ALU+PP+GLASS	IP20
JY-COB-DL-15W	AC180-280V	15W	1200lm	≥80	0.5	90°	COB	5" 165MM	Φ140	ALU+PP+GLASS	IP20
JY-COB-DL-20W	AC180-280V	20W	1600lm	≥80	0.5	90°	COB	8" 225MM	Φ200	ALU+PP+GLASS	IP20
JY-COB-DL-30W	AC180-280V	30W	2400lm	≥80	0.5	90°	COB	8" 225MM	Φ200	ALU+PP+GLASS	IP20

Surface CB



Model	Voltage	Power(W)	Lumen output(lm)	CRI	PF	Beam Angle	Led model	Product size	Work term	Material	IP
JY-surface-20	AC100-240V	20W	1800lm	≥80	0.9	90°	COB	5" 170MM	-20~50℃	ALU+GLASS	IP20
JY-surface-30	AC100-240V	30W	2700lm	≥80	0.9	100°	COB	8" 220MM	-20~55℃	ALU+GLASS	IP20
JY-surface-40	AC100-240V	40W	3600lm	≥80	0.9	100°	COB	10" 300MM	-20~55℃	ALU+GLASS	IP20

FEATURES :

- SMD chip,external driver
- Diecast Alu. body for excellcent heat dissipation
- Lifetime 25,000hrs

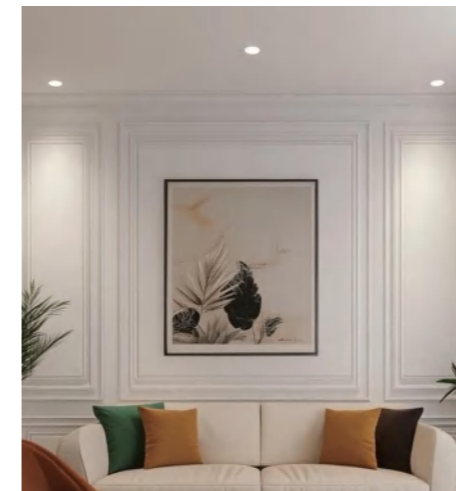

Model	Voltage	Power(W)	Lumen output	CRI	PF	Beam Angle	Led model	Material	IP
JY-DL-M-ECO-7W12.5	AC180-264V	7W	490lm	>80	>0.5	120°	SMD	Aluminium Housing	IP20
JY-DL-MECO-3C-7W12.5	AC180-264V	7W	490lm	>80	>0.5	120°	SMD	Aluminium Housing	IP20
JY-DL-ECO-7W12.5	AC180-264V	7W	490lm	>80	>0.5	120°	SMD	Aluminium Housing	IP20
JY-DL-ECO-3C-7W12.5	AC180-264V	7W	490lm	>80	>0.5	120°	SMD	Aluminium Housing	IP20

## Surface Mount

### FEATURES

- COB integrated chip
- Diecast Alu. body for excellent heat dissipation



Model	Voltage	Power(W)	Lumen output	CRI	PF	Beam Angle	Led model	Product size (mm)	Work term	Material	IP
JY-A062-5-1	AC85-265V	5W	240lm	≥85	≥0.95	45°	COB	Φ75*H25	-20~50°C	ALUMINUM PLASTIC	IP20
JY-A062-5-2	AC85-265V	5W	240lm	≥85	≥0.95	45°	COB	Φ75*H25	-20~55°C	ALUMINUM PLASTIC	IP20
JY-A062-10	AC85-265V	7/10W	315/450lm	≥85	≥0.9	45°	COB	Φ105*H35	-20~55°C	ALUMINUM PLASTIC	IP20

## Surface Mount

### FEATURES

- Available with different color Reflectors
- Effective heat sink design
- Reflector optics to create intense light beam

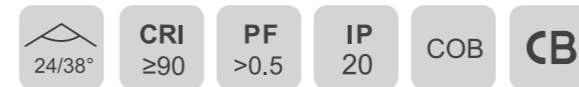

Model	Voltage	Power(W)	Lumen out put	Material
JY-CY-12W	AC110-240V	12W	1080lm	Aluminium
JY-CY-18W	AC110-240V	18W	1620lm	Aluminium





### FEATURES

- Long life, 3-Year Warranty
- Foldable design for flexible light adjustment
- High quality isolated built-in driver
- Die-cast alu body for good heat dissipation
- Material: ALU



CB

Model	Voltage	Power(W)	CCT(K)	Lumen output (lm)	lm/W	Beam Angle	CRI	Product size (mm)
JY-DL12-R-12W	AC85-265V	12	3000K/4000K/6500K	960lm	80lm/W	38°	>80	Φ78*H100
JY-DL20-R-20W	AC85-265V	20	3000K/4000K/6500K	1600lm	80lm/W	38°	>80	Φ88*H130

FEATURES

- PA housing with aluminum heatsink inside for efficient heat dissipation
- 25° tilt angle, beam angle 38°
- Front side IP44 for bathroom
- Long life and energy saving



Model	Voltage	Power(W)	CCT	Lumen output (lm)	lm/W	Beam Angle	CRI	Product size (mm)
JY-SPL-3W	AC110-265V	3W	3000K/6500K	240lm	80lm/W	38°	>80	Φ75*H35
JY-SPL-6W	AC110-265V	6W	3000K/4000K/6500K	480lm	80lm/W	38°	>80	Φ90*H40
JY-SPL-9W	AC110-265V	9W	3000K+Blue	720lm	80lm/W	38°	>80	Φ100*H50

TRIMLESS DOWN LIGHT



CB

Model	Voltage	Power(W)	CCT	Lumen output (lm)	lm/W	Hole size	CRI	Product size (mm)
JY-TR-SQ-10W	AC110-265V	10W	3000K/4000K/6500K	850lm	85lm/W	50mm<CUT <70mm	>80	100*100*H20
JY-TR-SQ-15W	AC110-265V	15W	3000K/4000K/6500K	1275lm	85lm/W	50mm<CUT <95mm	>80	120*120*H20
JY-TR-SQ-22W	AC110-265V	22W	3000K/4000K/6500K	2090lm	95lm/W	50mm<CUT <140mm	>80	170*170*H20
JY-TR-SQ-32W	AC110-265V	32W	3000K/4000K/6500K	3200lm	100lm/W	50mm<CUT <190mm	>80	225*225*H20



CB

Model	Voltage	Power(W)	CCT	Lumen output (lm)	lm/W	Hole size	CRI	Product size (mm)
JY-TR-R-10W	AC110-265V	10W	3000K/4000K/6500K	850lm	85lm/W	50mm<CUT <70mm	>80	Φ100*H20
JY-TR-R-15W	AC110-265V	15W	3000K/4000K/6500K	1275lm	85lm/W	50mm<CUT <95mm	>80	Φ120*H20
JY-TR-R-22W	AC110-265V	22W	3000K/4000K/6500K	2090lm	95lm/W	50mm<CUT <140mm	>80	Φ170*H20
JY-TR-R-32W	AC110-265V	32W	3000K/4000K/6500K	3200lm	100lm/W	50mm<CUT <190mm	>80	Φ225*H20

**FEATURES:**

- Alu frame, flicker free
- UGR<19 available
- Long life up to 50,000hrs
- 3CCT available by dip-switch
- IP20 and IP54 for front side for options

Available with:

- A** 210LM/W
- B** 185LM/W
- C** 160LM/W
- D** 140LM/W
- E** 110LM/W  
120LM/W

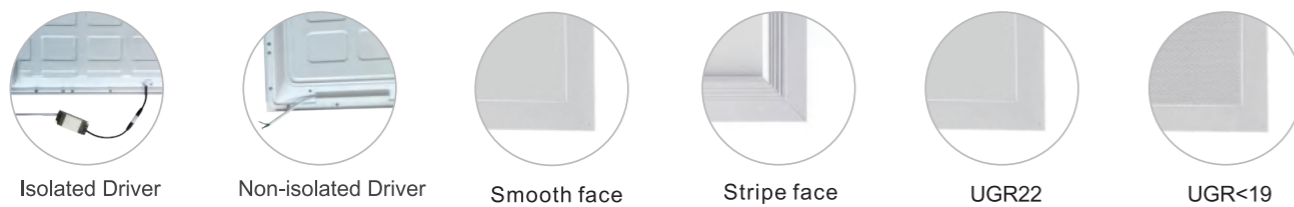
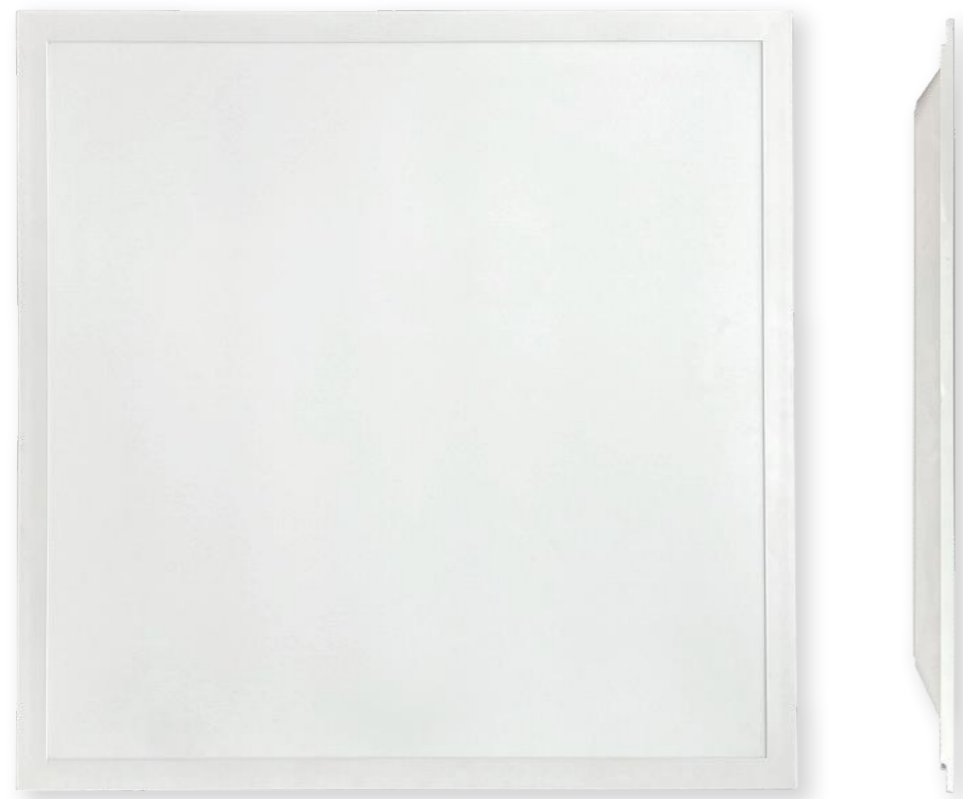

Philips, Lifud, Eaglerise

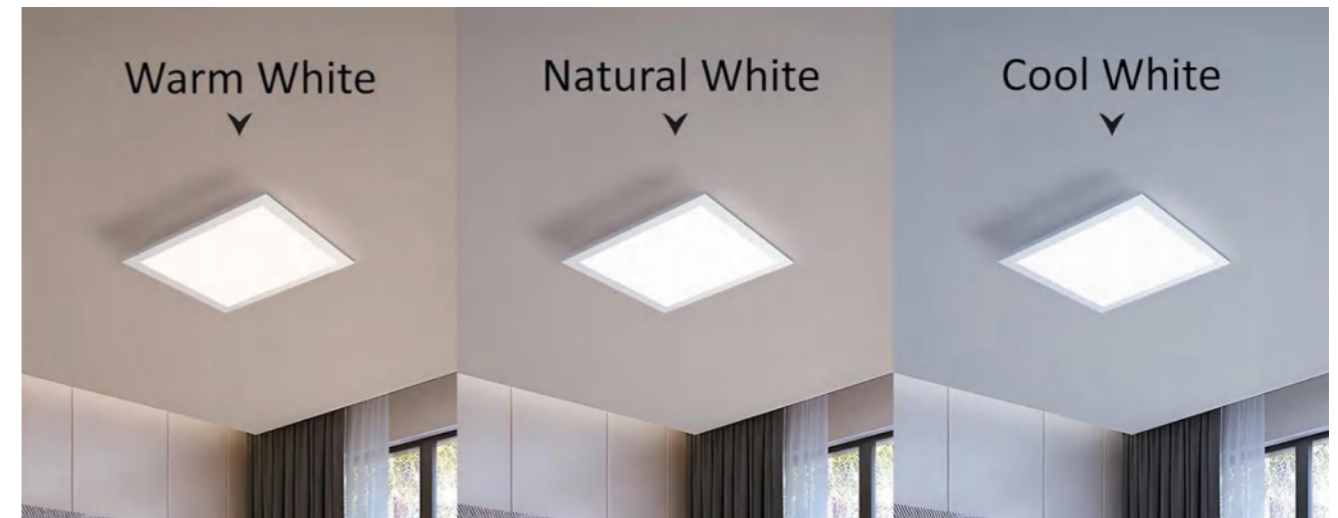
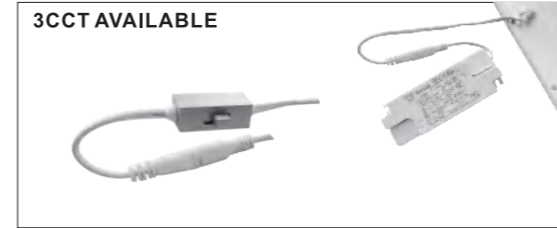

**DALI 0-10V option 1CCT / 3CCT available**

Model	Size L*W*H(mm)	Power(W)	Voltage(V)	Lumen (lm)	CRI	PF	Beam Angle	Lifetime(hrs)
JY-3030-13W-E	295*295*34	13	AC220-240V	1300 ± 10%	80	0.9	120°	30000
JY-3060-20W-E	295*595*34	20	AC220-240V	2000 ± 10%	80	0.9	120°	30000
JY-6060-36W-E	595*595*34	36	AC220-240V	3600 ± 10%	80	0.9	120°	30000
JY-6262-40W-E	620*620*34	40	AC220-240V	4000 ± 10%	80	0.9	120°	30000
JY-30120-36W-E	295*1195*34	36	AC220-240V	3600 ± 10%	80	0.9	120°	30000
JY-60120-60W-E	595*1195*34	64	AC220-240V	6400 ± 10%	80	0.9	120°	30000

Hanging Installation

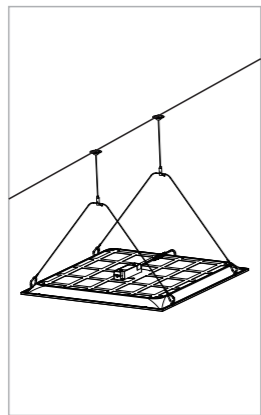

Recessed Installation

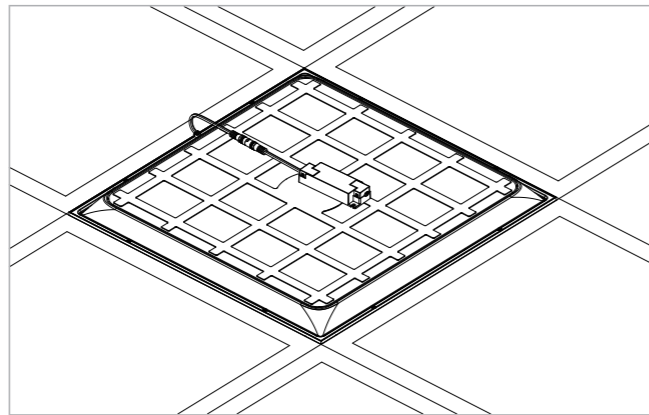

Surface Mounted Kit

Dimensions:  
600x600,620x620,300x300,  
300x600,300x1200,600x1200mm  
Height: 50/58/68/70/75mm



Screw type



Screwless type

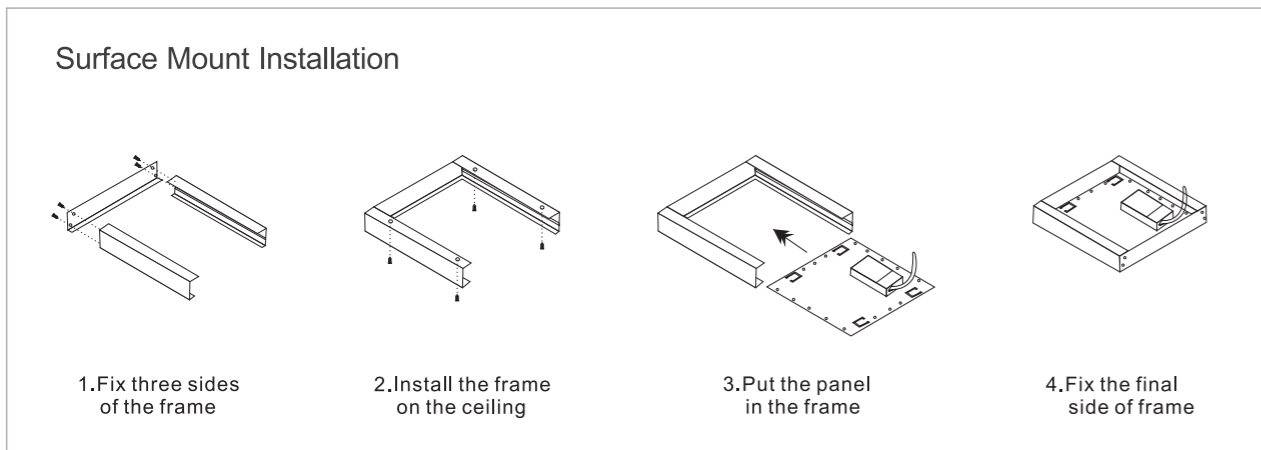
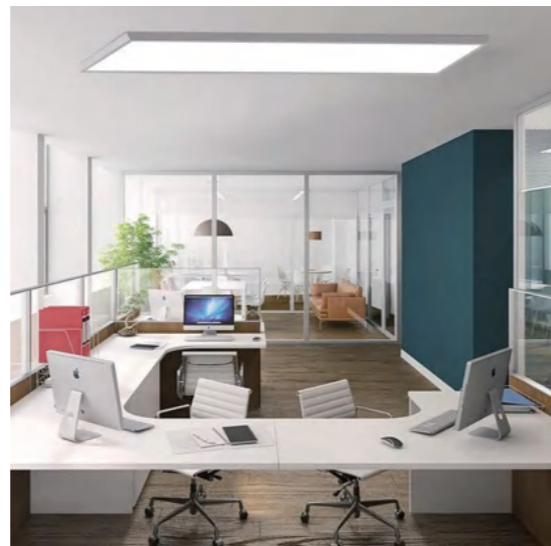

SMART PANEL

FEATURES :

- Radar sensor type available
- Detection range: max.5m.
- Mounting height: 3-4m.

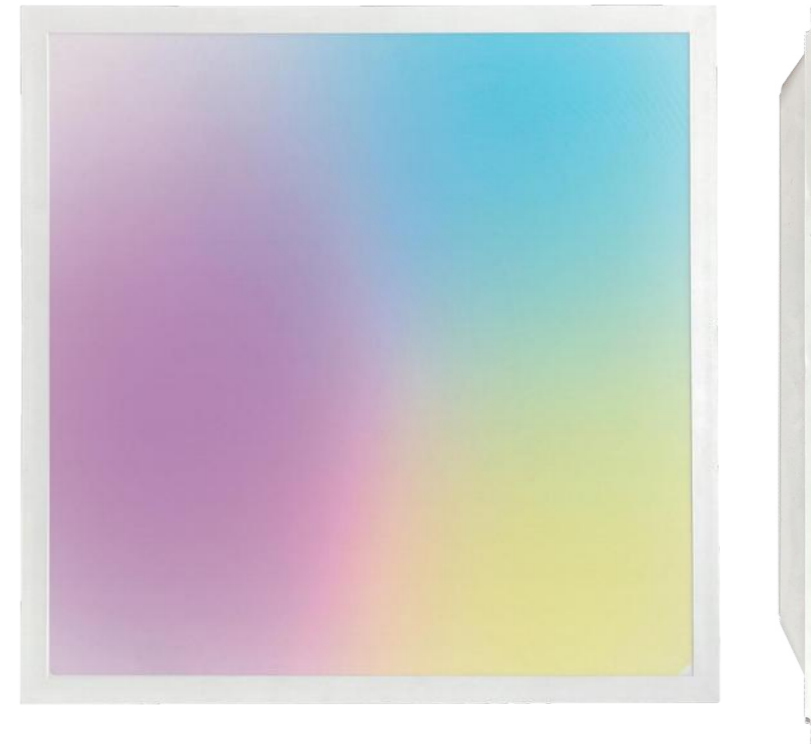

AC 220-240V 50/60Hz	CRI 80	120°	PF> 0.9	UGR <19	*** *** *** IP20
---------------------------	-----------	------	------------	------------	---------------------------

Model	Size L*W*H(mm)	Power(W)	Light Efficacy	CCT	Luminous Flux	UGR	Remark
JY-6060-30S1	595*595*34	40W	120lm/W	2700-6500K	4800lm	<19	Tuya smart
JY-6060-30S2	595*595*34	40W	120lm/W	RGB+2700-6500K	4800lm	<19	Tuya smart

LED CEILING(PATENT DESIGN)

FEATURES :

- Combined with main light+auxiliary light,
- Main light is 2700-6500k CCT selectable, uxiliary light is is 2700k
- Anti-glare design
- With remote controller

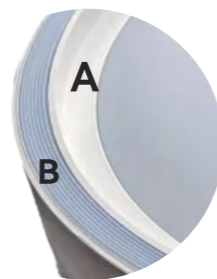

A: Trim Colors

- White/Blue/Gold/Pink/ Brown available

B:Auxiliary Light

Fast mounting Bracket



Model	Voltage(V)	Main light+ Auxiliary light(W)	Light Efficacy	Life(hrs)	CRI	Size(D*L)mm	Dimmable	DF	IP	Energy Class
JY-CL1307I	AC176-264V	24W+8W	70lm/W	30000	90	Φ425*63mm	NO	0.7	IP40	F
JY-CL1307II	AC176-264V	45W+12W	70lm/W	30000	90	Φ520*77mm	NO	0.7	IP40	F



FEATURES :

- Elegant design, IP42
- Long life and energy saving
- Nice design PS Cover
- Easy installation
- CCT by dip switch or by controller



CCT by Dip Switch



Light source board



Power	Voltage(V)	Efficacy(lm/w)	3CCT	PF	CRI	Dimension	Material
18W	AC220-240V	83LM/W	3000/4000/6500K	>0.9	>80	φ 230*41mm	ABS+PS
24W	AC220-240V	95LM/W	3000/4000/6500K	>0.9	>80	φ 300*41mm	ABS+PS
36W	AC220-240V	95LM/W	3000/4000/6500K	>0.9	>80	φ 400*42mm	ABS+PS
48W	AC220-240V	98LM/W	3000/4000/6500K	>0.9	>80	φ 500*43mm	ABS+PS



**FEATURES :**

- Elegant design
- Long life and energy saving
- Nice design prismatic cover UGR < 19
- Easy installation
- CCT by dip switch or by controller



**FEATURES :**

- Elegant design
- Long life and energy saving
- Nice design prismatic cover UGR < 19
- Easy installation
- CCT by dip switch or by controller

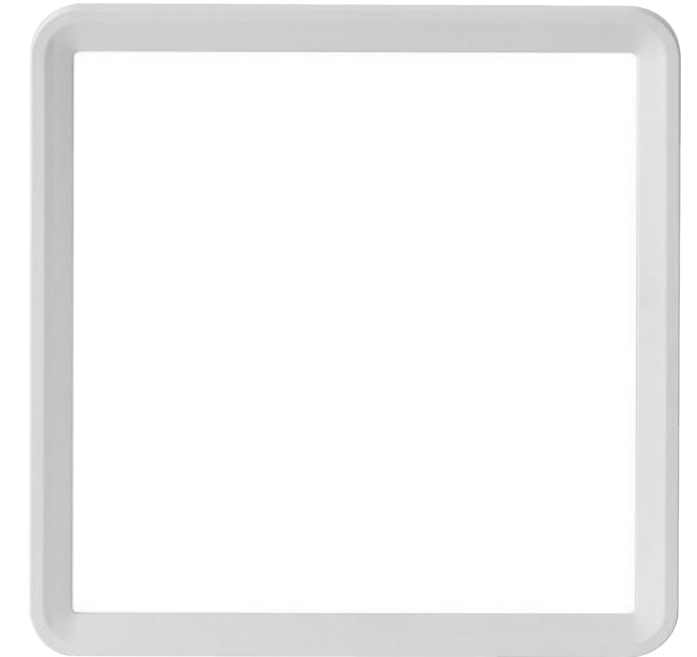
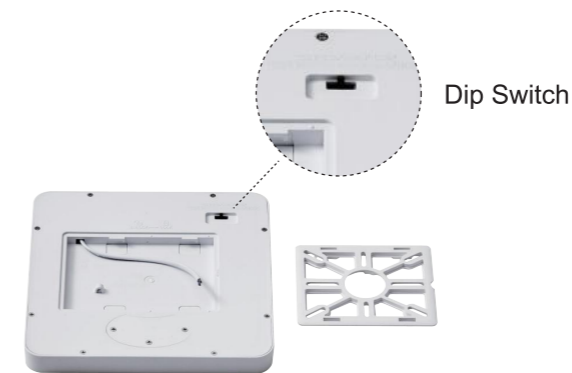

Power	Voltage(V)	Efficacy(lm/w)	3CCT	PF	CRI	Dimension	Material	Life
12W	AC220-240V	90-100-95LM/W	3000/4000/6500K	>0.5	>80	φ230*23mm	ABS+PS	20000hrs
24W	AC220-240V	90-100-95LM/W	3000/4000/6500K	>0.5	>80	φ300*23mm	ABS+PS	20000hrs
32W	AC220-240V	100-110-105LM/W	3000/4000/6500K	>0.9	>80	φ400*25mm	ABS+PS	20000hrs
40W	AC220-240V	100-110-105LM/W	3000/4000/6500K	>0.9	>80	φ500*25mm	ABS+PS	20000hrs
50W	AC220-240V	105-115-110LM/W	3000/4000/6500K	>0.9	>80	φ600*27mm	ABS+PS	20000hrs

Power	Voltage(V)	Efficacy(lm/w)	3CCT	PF	CRI	Dimension	Material	Life	Flicker free
18W	AC220-240V	85-95-90LM/W	3000/4000/6500K	>0.5	>80	230*230*23mm	ABS+PS	30000hrs	YES
24W	AC220-240V	85-95-90LM/W	3000/4000/6500K	>0.5	>80	300*300*25mm	ABS+PS	30000hrs	YES
32W	AC220-240V	95-105-100LM/W	3000/4000/6500K	>0.9	>80	400*400*25mm	ABS+PS	30000hrs	YES
40W	AC220-240V	95-105-100LM/W	3000/4000/6500K	>0.9	>80	500*500*25mm	ABS+PS	30000hrs	YES
50W	AC220-240V	105-100-110LM/W	3000/4000/6500K	>0.9	>80	300*1200*28mm	ABS+PS	30000hrs	YES
60W	AC220-240V	110-120-115LM/W	3000/4000/6500K	>0.9	>80	600*900*28mm	ABS+PS	30000hrs	YES

**FEATURES :**

- Ultra thin
- Long life and energy saving
- Nice design PVC Cover
- Easy installation
- 3CCT by wall switch



○ white

**FEATURES :**

- Long life and energy saving
- Nice design PP Cover
- Easy installation
- 3CCT by dip switch



● black



○ silver



● gold



○ white



● black

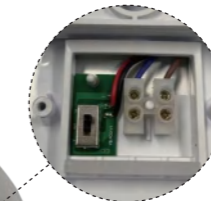

Dip Switch



IP54,1CCT/3CCT



Model	Voltage(V)	Power(W)	Size(D*H)mm	3CCT	PF	CRI	Material
JY-CL245 -18W	AC220-240V	18	Φ245x50	3000-4000-6500K	0.5	80	PVC
JY-CL300 -24W	AC220-240V	24	Φ300x55	3000-4000-6500K	0.5	80	PVC
JY-CL450 -36W	AC220-240V	36	Φ450x55	3000-4000-6500K	0.5	80	PVC

IP65



Model	Voltage(V)	Power(W)	Size(D*H)mm	3CCT	PF	CRI	Material
JY-CL20-R-20W	AC165-265V	20	Φ180mm*H50	3000-4000-6500K	0.5	80	PP
JY-CL28-R-28W	AC165-265V	28	Φ220mm*H50	3000-4000-6500K	0.5	80	PP
JY-CL40-R-40W	AC165-265V	40	Φ300mm*H50	3000-4000-6500K	0.5	80	PP
JY-CL50-R-50W	AC165-265V	50	Φ400mm*H50	3000-4000-6500K	0.5	80	PP

**FEATURES :**

- >20,000hrs lifetime 2-Year Warranty
- High-quality plastic cover for uniform light diffusion
- Excellent sealing and high efficiency
- Waterproof, anti-fouling, and moisture-resistant



IP65



Model	Voltage(V)	Power(W)	Lumen	Size(mm)	Beam angle	CCT(K)	PF	CRI	Material
JY-15R-15W	AC110-265V	15	80Lm/w	D165MM	90°	3000K/4000K/6500K	0.5	80	PP
JY-20R-20W	AC110-265V	20	80Lm/w	D230MM	90°	3000K/4000K/6500K	0.5	80	PP
JY-30R-30W	AC110-265V	30	80Lm/w	D230MM	90°	3000K/4000K/6500K	0.5	80	PP
JY-15O-15W	AC110-265V	15	80Lm/w	D120*210MM	90°	3000K/4000K/6500K	0.5	80	PP
JY-20O-20W	AC110-265V	20	80Lm/w	D140*260MM	90°	3000K/4000K/6500K	0.5	80	PP
JY-30O-30W	AC110-265V	30	80Lm/w	D140*260MM	90°	3000K/4000K/6500K	0.5	80	PP

**LED Ceiling Light**

**FEATURES :**

- Easy installation
- Long life and energy saving
- High quality and elegant designs



Model	Voltage(V)	Power(W)	CCT	Lumen(lm)	CRI	Size(D*L)mm	DF	Diffuser	Life(hrs)	IP	Energy Class
JY-CL-12	AC220-240V	12W	1CCT/3CCT	80lm/w, 120lm/w	>80	260*70mm	>0.7	PMMA/PVC	15000	IP20/IP44	F
JY-CL-18	AC220-240V	18W	1CCT/3CCT	80lm/w, 120lm/w	>80	330*70mm	>0.7	PMMA/PVC	15000	IP20/IP44	F
JY-CL-24	AC220-240V	24W	1CCT/3CCT	80lm/w, 120lm/w	>80	380*80mm	>0.7	PMMA/PVC	15000	IP20/IP44	F



FEATURES :

- Elegant design
- Long life and energy saving
- Nice design prismatic cover
- Easy installation
- CCT and RGB selectable by wall switch or by controller



Power	CCT	Lumen without	PF	DF	Life	Flicker free	Dimension	Chassis size	Material
24W	3000K/4000K/6500K	2400LM	>0.5	>0.5	15000hrs	YES	Φ400*105mm	Φ350	PMMA+Iron
36W	3000K/4000K/6500K	3600LM	>0.5	>0.5	15000hrs	YES	Φ400*105mm	Φ350	PMMA+Iron
24W	3000K-4500K-6000K	2640LM	>0.5	>0.7	15000hrs	YES	Φ400*105mm	Φ350	PMMA+Iron
36W	3000K-4500K-6000K	3600LM	>0.5/0.7	>0.9	15000hrs	YES	Φ400*105mm	Φ350	PMMA+Iron
24W	3000K-4500K-6000K+RGB	2640LM	>0.5	>0.7	15000hrs	YES	Φ400*105mm	Φ350	PMMA+Iron
36W	3000K-4500K-6000K+RGB	3600lm	>0.5/0.9	>0.7 /0.9	15000hrs	YES	Φ400*105mm	Φ350	PMMA+Iron
40W	3000K/4000K/6500K	4400LM	>0.5/0.9	>0.9	15000hrs	YES	Φ500*105mm	Φ450	PMMA+Iron
50W	3000K/4000K/6500K	5500LM	>0.5/0.9	>0.9	15000hrs	YES	Φ500*105mm	Φ450	PMMA+Iron
40W	3000K-4500K-6000K	4400LM	>0.5/0.9	>0.9	15000hrs	YES	Φ500*105mm	Φ450	PMMA+Iron
50W	3000K-4500K-6000K	5500LM	>0.5/0.9	>0.9	15000hrs	YES	Φ500*105mm	Φ450	PMMA+Iron
40W	3000K-4500K-6000K	4400LM	>0.5/0.9	>0.9	15000hrs	YES	Φ500*105mm	Φ450	PMMA+Iron
50W	3000K-4500K-6000K+RGB	5500LM	>0.5/0.9	>0.9	15000hrs	YES	Φ500*105mm	Φ450	PMMA+Iron

Prismatic cover



FEATURES :

- Elegant design
- Long life and energy saving
- Nice design prismatic cover
- Easy installation
- CCT and RGB selectable by wall switch or by controller



Power	CCT	Lumen without	PF	DF	Life	Flicker free	Dimension	Chassis size	Material
24W	3000K/4000K/6500K	2400LM	>0.5	>0.5	15000hrs	YES	Φ400*105mm	Φ350	PMMA+Iron
36W	3000K/4000K/6500K	3600LM	>0.5	>0.5	15000hrs	YES	Φ400*105mm	Φ350	PMMA+Iron
24W	3000K-4500K-6000K	2640LM	>0.5	>0.7	15000hrs	YES	Φ400*105mm	Φ350	PMMA+Iron
36W	3000K-4500K-6000K	3600LM	>0.5/0.7	>0.9	15000hrs	YES	Φ400*105mm	Φ350	PMMA+Iron
24W	3000K-4500K-6000K+RGB	2640LM	>0.5	>0.7	15000hrs	YES	Φ400*105mm	Φ350	PMMA+Iron
36W	3000K-4500K-6000K+RGB	3600lm	>0.5/0.9	>0.7 /0.9	15000hrs	YES	Φ400*105mm	Φ350	PMMA+Iron
40W	3000K/4000K/6500K	4400LM	>0.5/0.9	>0.9	15000hrs	YES	Φ500*105mm	Φ450	PMMA+Iron
50W	3000K/4000K/6500K	5500LM	>0.5/0.9	>0.9	15000hrs	YES	Φ500*105mm	Φ450	PMMA+Iron
40W	3000K-4500K-6000K	4400LM	>0.5/0.9	>0.9	15000hrs	YES	Φ500*105mm	Φ450	PMMA+Iron
50W	3000K-4500K-6000K	5500LM	>0.5/0.9	>0.9	15000hrs	YES	Φ500*105mm	Φ450	PMMA+Iron
40W	3000K-4500K-6000K	4400LM	>0.5/0.9	>0.9	15000hrs	YES	Φ500*105mm	Φ450	PMMA+Iron
50W	3000K-4500K-6000K+RGB	5500LM	>0.5/0.9	>0.9	15000hrs	YES	Φ500*105mm	Φ450	PMMA+Iron



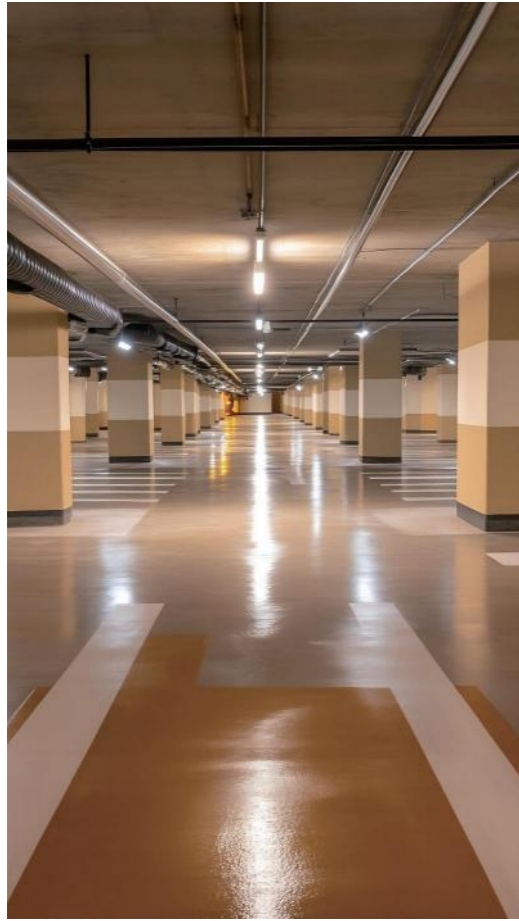

Model	Voltage(V)	Power(W)	DF	length	Lumen(lm)	CCT
T5 battens 4W	AC100-277V	4	0.7	1ft	400	3000/4000/6500K
T5 battens 8W	AC100-277V	8	0.7	2ft	800	3000/4000/6500K
T5 battens 10W	AC100-277V	10	0.7	3ft	1000	3000/4000/6500K
T5 battens 14W	AC100-277V	14	0.7	4ft	1400	3000/4000/6500K
T5 battens 18W	AC100-277V	18	0.7	5ft	1800	3000/4000/6500K

JY1-1



JY2-1



JY3-1



Model	Voltage(V)	Power(W)	PF	Length(mm)	Lumen(lm)	CCT	CRI	Material
JY1-1	AC100-240V	9W118W136W	0.5	60/90/120	80lm/W	3000/4000/6500K	80	PC+Alu
JY2-1	AC100-240V	9W118W136W	0.5	60/90/120	80lm/W	3000/4000/6500K	80	PC+Alu
JY3-1	AC100-240V	9W118W136W	0.5	60/90/120	80lm/W	3000/4000/6500K	80	PC+Alu



Model	Voltage(V)	Power(W)	DF	Dimension(mm)	Lumen(lm)	CCT	CRI	Material
JY-T8 Batten-9W	AC100-277V	9	0.5	L=600mm	810	3000/4000/6500K	80	PC+Alu
JY-T8 Batten-13W	AC100-277V	13	0.5	L=900mm	1100	3000/4000/6500K	80	PC+Alu
JY-T8 Batten-19W	AC100-277V	19	0.5	L=1200mm	1500	3000/4000/6500K	80	PC+Alu

WEATHER PROOF BATTEN

IP65



Model	Power(W)	Voltage(V)	Size(cm )	Lumen(lm)	PF	CRI	Clips	Driver	Flicker
JFC060	20W	AC220-240V	58x7.6x7.2	2500lm	0.95	80	6Pcs	Non-isolated	No
JFC120	40W	AC220-240V	116.5x7.6x7.2	5000lm	0.95	80	10Pcs	Non-isolated	No
JFC150	50W	AC220-240V	146.5x7.6x7.2	6250lm	0.95	80	12Pcs	Non-isolated	No
JFC150	60W	AC220-240V	146.5x7.6x7.2	7500lm	0.95	80	12Pcs	Non-isolated	No

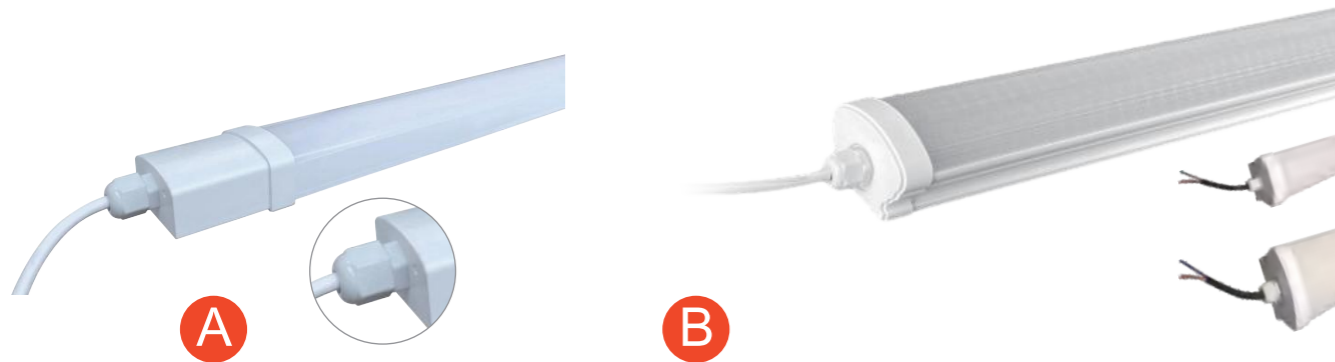

Model	Power(W)	Voltage(V)	Lumen(lm)	PF	CRI	Materials	Size(mm)
JY-IP65batten 15W-A	15	AC165-265V	1350	0.5	80	Full PC	630*42*25mm
JY-IP65batten 32W-A	32	AC165-265V	2880	0.5	80	FULL PC	1230*42*25mm
JY-IP65batten 18W-B	18	AC165-265V	1620	0.5	80	ALU+PC	610*62*52mm
JY-IP65batten 27W-B	27	AC165-265V	2430	0.5	80	ALU+PC	610*68*48mm
JY-IP65batten 36W-B	36	AC165-265V	3240	0.5	80	ALU+PC	1210*62*52mm
JY-IP65batten 54V-B	54	AC165-265V	4860	0.5	80	ALU+PC	1210*68*48mm

Flame retardant PC Holder  
Single-ended connection  
3 position terminal  
Earth connection

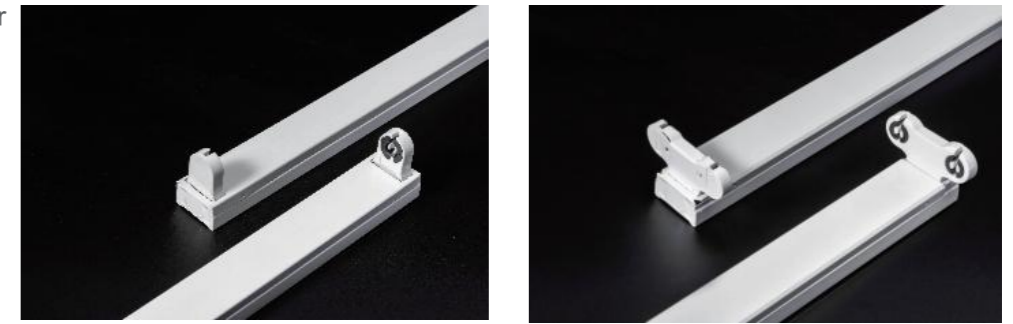

Single Tube

Double Tubes

Model	Dimension (mm)	Description	Thickness(mm)	Material of Plug	Color of Plug	Diameter of Wire(mm)
JY-60-S	622*40*57/ 622*40*24mm	0.6m with single holder	0.3mm	PC	White	0.5mm
JY-120-S	1232*40*57/ 1232*40*24mm	1.2m with single holder	0.3mm	PC	White	0.5mm
JY-150-S	1532*40*57/ 1532*40*24mm	1.5m with single holder	0.3mm	PC	White	0.5mm

Model	Dimension (mm)	Description	Thickness(mm)	Material of Plug	Color of Plug	Diameter of Wire(mm)
JY-60-D	622*40*57/ 622*40*24mm	0.6m with double holder	0.3mm	PC	White	0.5mm
JY-120-D	1232*40*57/ 1232*40*24mm	1.2m with double holder	0.3mm	PC	White	0.5mm
JY-150-D	1532*40*57/ 1532*40*24mm	1.5m with double holder	0.3mm	PC	White	0.5mm



Model	Dimension (mm)	Description	Thickness(mm)	Material of Plug	Color of Plug	Diameter of Wire(mm)
JY-120-S-C	1232*80*58/ 1232*40*24mm	1.2m with single holder & reflector	0.3mm	PC	White	0.5mm
JY-150-S-C	1532*80*58/ 1532*40*24mm	1.5m with single holder & reflector	0.3mm	PC	White	0.5mm

Model	Dimension (mm)	Description	Thickness(mm)	Material of Plug	Color of Plug	Diameter of Wire(mm)
JY-120-D-C	1232*80*58/ 1232*40*24mm	1.2m with double holder & reflector	0.3mm	PC	White	0.5mm
JY-150-D-C	1532*80*58/ 1532*40*24mm	1.5m with double holder & reflector	0.3mm	PC	White	0.5mm

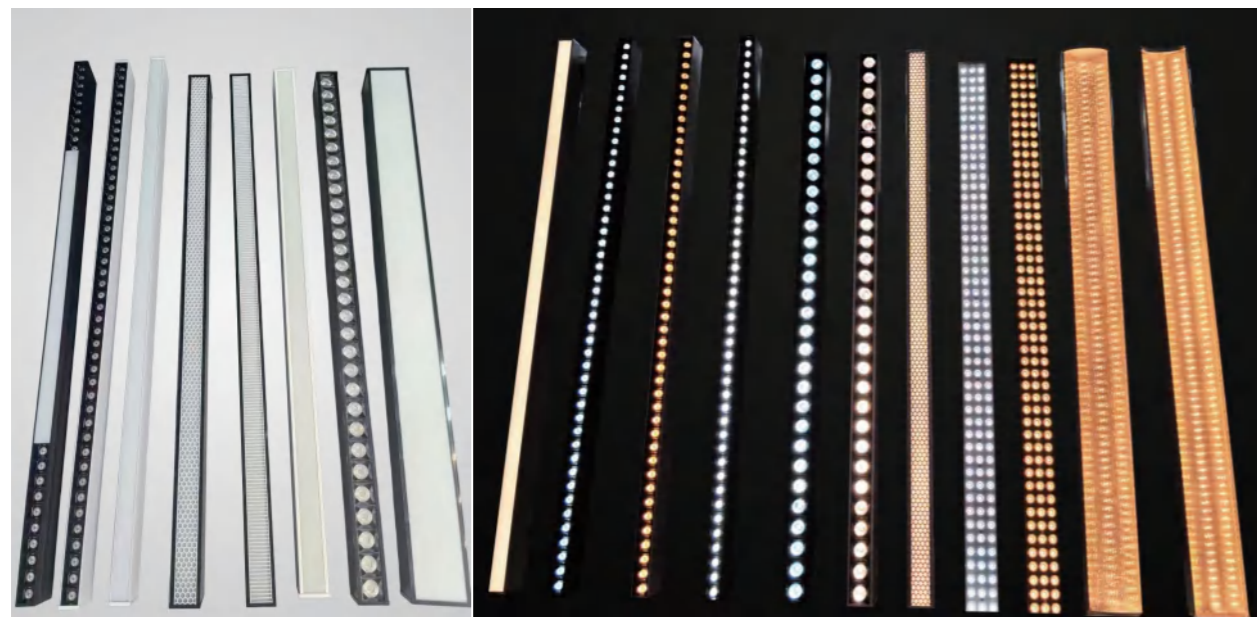
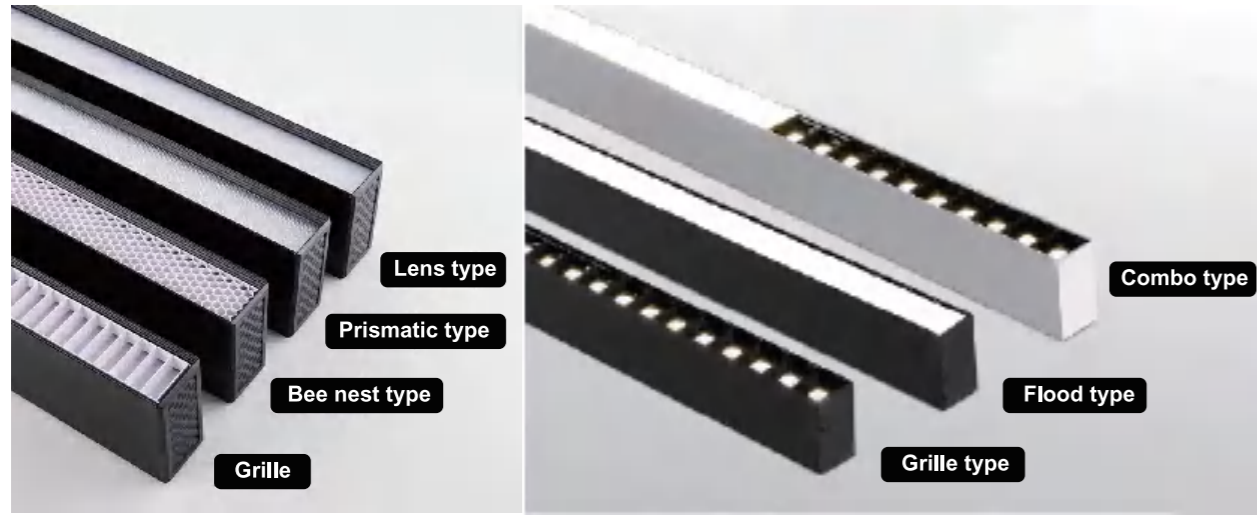

Model	Voltage	Power(W)	Product size	CCT (K)	Material	IP
JY-linear-45-1	AC165-265V	45W	1200*35*70MM	3000K/4000K/6500K	PVC/ALU	IP20
JY-linear-45-2	AC165-265V	45W	1200*50*70MM	3000K/4000K/6500K	PVC/ALU	IP20
JY-linear-68	AC165-265V	68W	1200*100*80MM	3000K/4000K/6500K	PVC/ALU	IP20

Installation diagram

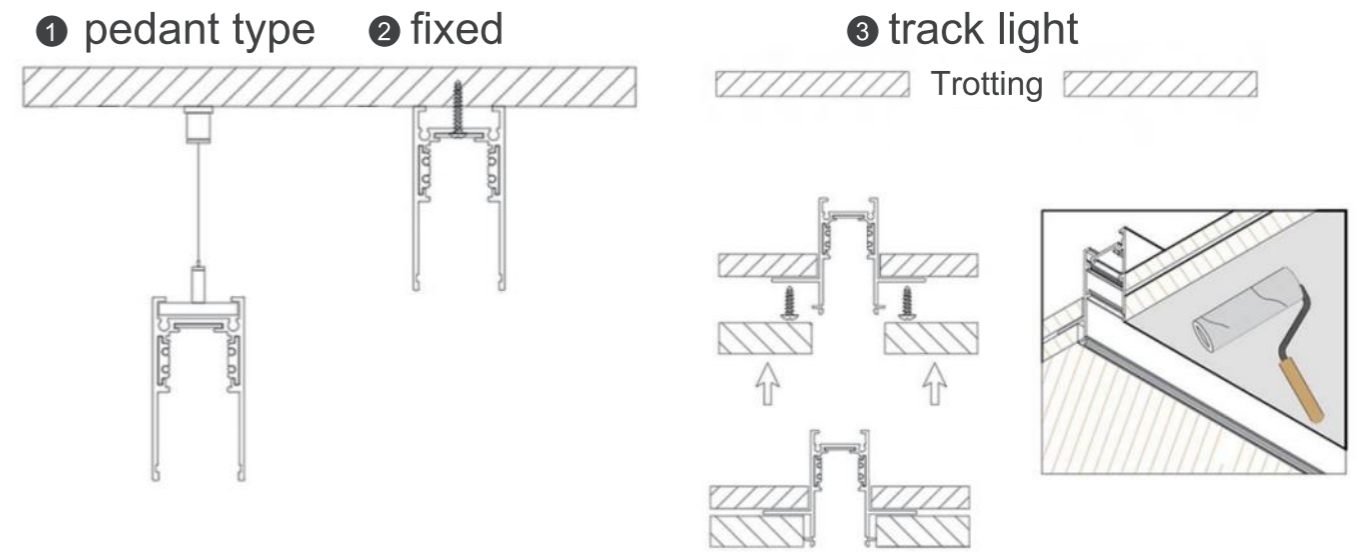

4. fangtong installation way

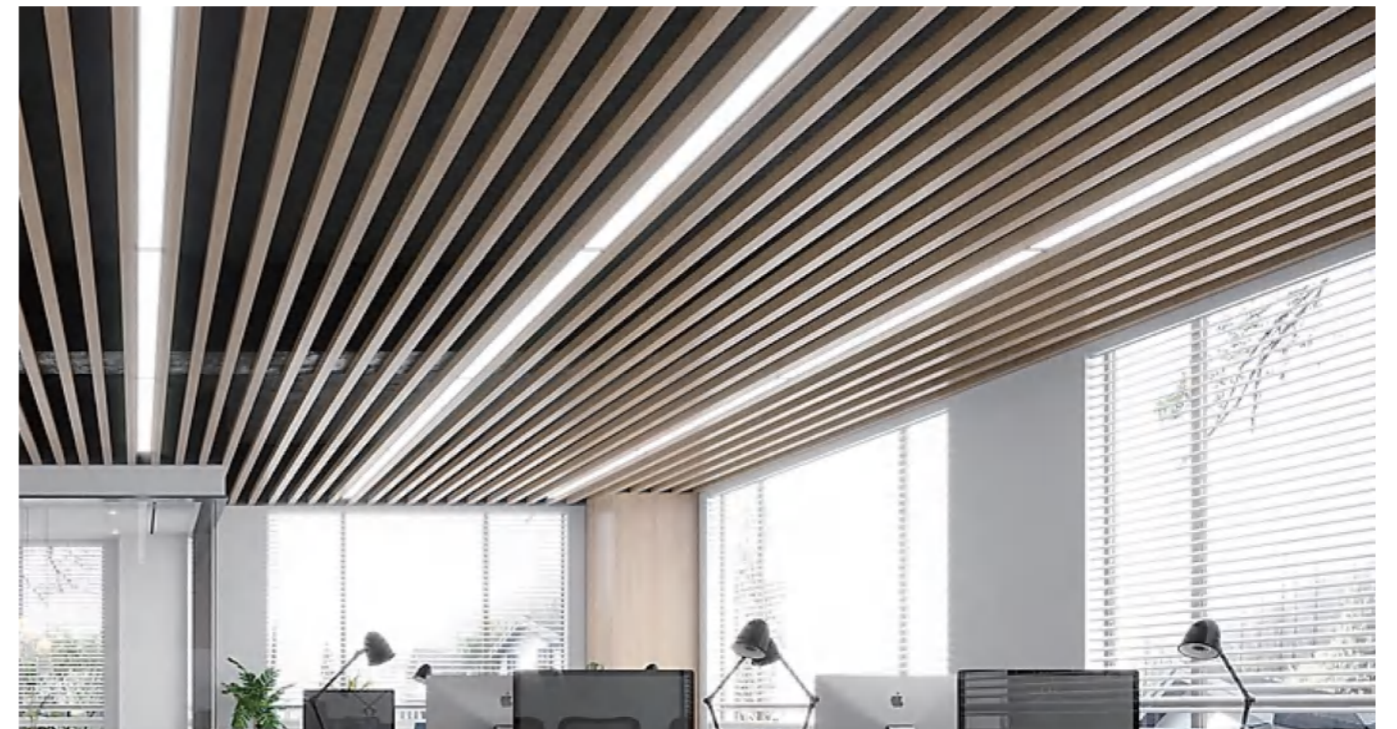



Model	Voltage	Power(W)	Product size	CCT (K)	Material	IP
JY-PVC-OFL-20	AC165-265V	20W	1200*50*35MM	3000K/4000K/6500K	PVC+IRON +PS	IP20
JY-PVC-OFL-22	AC165-265V	22W	1200*70*35MM	3000K/4000K/6500K	PVC+IRON +PS	IP20
JY-PVC-OFL-40	AC165-265V	40W	1200*100*35MM	3000K/4000K/6500K	PVC+IRON +PS	IP20
JY-PVC-OFL-50	AC165-265V	50W	1200*130*42MM	3000K/4000K/6500K	PVC+IRON +PS	IP20
JY-PVC-OFL-66	AC165-265V	66W	1200*180*42MM	3000K/4000K/6500K	PVC+IRON +PS	IP20
JY-PVC-OFL-88	AC165-265V	88W	1200*280*42MM	3000K/4000K/6500K	PVC+IRON +PS	IP20

Model	Voltage	Power(W)	Product size	CCT (K)	Material	IP
JY-OFL-22-1	AC165-265V	22W	1200*50MM	3000K/4000K/6500K	Iron +PP	IP20
JY-OFL-22-2	AC165-265V	22W	1200*65MM	3000K/4000K/6500K	Iron +PP	IP20
JY-OFL-22-3	AC165-265V	22W	1200*95MM	3000K/4000K/6500K	Iron +PP	IP20
JY-OFL-44-1	AC165-265V	44W	1200*140MM	3000K/4000K/6500K	Iron +PP	IP20
JY-OFL-44-2	AC165-265V	44W	1200*180MM	3000K/4000K/6500K	Iron +PP	IP20
JY-OFL-66-1	AC165-265V	66W	1200*280MM	3000K/4000K/6500K	Iron +PP	IP20

Model	Voltage	Power(W)	Product size	CCT (K)	Material	IP
JY-HPVC-OFL-32-1	AC165-265V	32W	1200*50*48MM	3000K/4000K/6500K	PVC+IRON+ Prismatic lens	IP20
JY-HPVC-OFL-32-2	AC165-265V	32W	1200*70*48MM	3000K/4000K/6500K	PVC+IRON+ Prismatic lens	IP20
JY-HPVC-OFL-45	AC165-265V	45W	1200*100*48MM	3000K/4000K/6500K	PVC+IRON+ Prismatic lens	IP20
JY-HPVC-OFL-65	AC165-265V	65W	1200*150*48MM	3000K/4000K/6500K	PVC+IRON+ Prismatic lens	IP20
JY-HPVC-OFL-88	AC165-265V	88W	1200*200*48MM	3000K/4000K/6500K	PVC+IRON+ Prismatic lens	IP20
JY-HPVC-OFL-126	AC165-265V	126W	1200*300*48MM	3000K/4000K/6500K	PVC+IRON+ Prismatic lens	IP20

FEATURES

- DOB/Linear solution, slim design
- PF>0.9, 140lm/W efficacy, 100-265Vac
- Die-cast aluminum shell with PC lens
- IP65 & IK08 design with long lifetime of 50,000 hrs



FEATURES

- DOB/Linear solution, slim design
- PF>0.9, 100-265Vac
- High efficacy 120lm/w, 140lm/w
- Die-cast aluminum with PC lens
- IP65 & IK08 design with long life of 50,000 hrs

3000K 4000K 6500K



Model	Size D*H(mm)	Wattage	Efficacy(lm/w)	Driver Type	Lifetime(hrs)
HB-100-2A	Φ298*119	100	120	DOB/Linear	50000
HB-150-2A	Φ298*119	150	120	DOB/Linear	50000
HB-200-2A	Φ336*122	200	120	DOB/Linear	50000

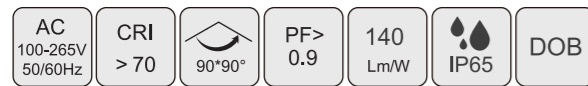

Model	Size D*H(mm)	Wattage	Lumen(lm)	Lifetime(hrs)
Diamond-100W	Φ284*50	100	14000	50000
Diamond-150W	Φ323*50	150	21000	50000
Compass-200W	Φ364*50	200	28000	50000

Model	Size D*H(mm)	Wattage	Efficacy(lm/w)	Driver Type	Lifetime(hrs)
HB-100-2B	Φ298*119	100	120	DOB/Linear	50000
HB-150-2B	Φ298*119	150	120	DOB/Linear	50000
HB-200-2B	Φ336*122	200	120	DOB/Linear	50000





FEATURES

- DOB/Linear driver solution, 110-265Vac
- High efficiency , PF>0.9,
- Die-cast aluminum with glass
- IP65 & IK07 design with long life of 50,000 hrs



3000K 4000K 6500K

AC 110-265V 50/60Hz | AC 220-240V 50/60Hz | CRI 80 | 120° | PF> 0.9 | 120 LmW | IP65

CE | ErP | LVD | EMC | RoHS COMPLIANT

Model	Size L*W*H(mm)	Wattage	Efficacy(lm/w)	Driver Type	Lifetime(hrs)
JYFL -10-TH	86*86*22	10	120	DOB/Linear	50000
JYFL -20-TH	98*82*24	20	120	DOB/Linear	50000
JYFL -30-TH	124*104*27	30	120	DOB/Linear	50000
JYFL -50-TH	172*135*28	50	120	DOB/Linear	50000
JYFL -100-TH	232*196*37	100	120	DOB/Linear	50000
JYFL -150-TH	303*235*39	150	120	DOB/Linear	50000
JYFL -200-TH	368*295*44	200	120	DOB/Linear	50000
JYFL -300-TH	406*328*48	300	120	DOB/Linear	50000

FEATURES

- DOB/Linear driver solution, 110-265Vac
- High efficiency , PF>0.9,
- Die-cast aluminum with glass
- IP65 & IK07 design with long life of 50,000 hrs



3000K 4000K 6500K

AC 110-265V 50/60Hz | AC 220-240V 50/60Hz | CRI 80 | 120° | PF> 0.9 | IP65

CE | ErP | LVD | EMC | RoHS COMPLIANT

Model	Size L*W*H(mm)	Wattage	Efficacy(lm/w)	Driver Type	Lifetime(hrs)
JYFL -10-XY	126*86*22	10	120	DOB/Linear	50000
JYFL -20-XY	137*107*20	20	120	DOB/Linear	50000
JYFL -30-XY	221*165*27	30	120	DOB/Linear	50000
JYFL -50-XY	221*165*27	50	120	DOB/Linear	50000
JYFL -100-XY	279*221*28	100	120	DOB/Linear	50000
JYFL -150-XY	380*294*37	150	120	DOB/Linear	50000
JYFL -200-XY	415*314*38	200	120	DOB/Linear	50000



### FEATURES

- No need wiring, easy to install
- Intelligent control with Timer, Dimming, Remote Control
- Material : ABS+PC
- IP65 design with long lifetime of 30,000 hrs

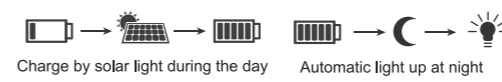

CCT : 7500±500K

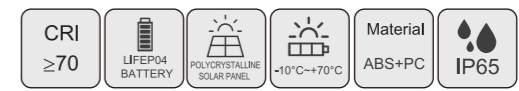

Model	Size L*W*H(mm)	Power	Solar Panel	LiFePO4 Battery	chargingtime (hrs)	Working time (hrs)
JY-TG-100W-1	200*160*55	100W	6V 6W	3.2V 5AH	6	10-12
JY-TG-200W-1	270*200*58	200W	6V 12W	3.2V 10AH	6	10-12
JY-TG-300W-1	308*230*60	300W	6V 15W	3.2V 15AH	6	10-12



**FEATURES**

- Intelligent light control + time control + remote control
- Charge Time: 6 hours with sunlight
- Discharge Time: 10-12 hours/night
- Lamp Housing Material: ABS+PC
- Cable: 5 meters

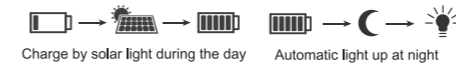

CCT : 7500±500K

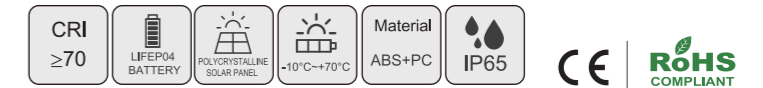

Model	Size L*W*H(mm)	Power	Solar Panel	LiFeP04 Battery	chargingtime(hrs)	Working time (hrs)
JY-TG-100W-2	240*168*55	100W	5V 6W	3.2V 5AH	6	10-12
JY-TG-200W-2	280*198*55	200W	5V 12W	3.2V 10AH	6	10-12
JY-TG-300W-2	330*238*55	300W	5V 18W	3.2V 15AH	6	10-12
JY-TG-400W-2	390*288*60	400W	5V 24W	3.2V 20AH	6	10-12

- Material : ABS+Glass
- Charge Time: 6 hours with sunlight
- Discharge Time: 10-12 hours/night
- IP66 & IK07 design with long lifetime of 50,000 hrs
- Flap design for easy maintenance and installation

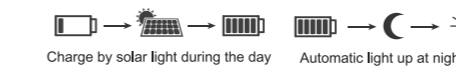

CCT : 7500±500K

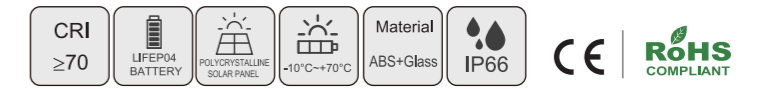

Model	Size L*W*H(mm)	Power	Solar Panel	LiFeP04 Battery	chargingtime(hrs)	Working time (hrs)
JY-TG-100W-3	193*146*46	100W	6V 5W	3.2V 4AH	6	10-12
JY-TG-200W-3	227*182*50	200W	6V 6W	3.2V 6AH	6	10-12
JY-TG-300W-3	255*208*62	300W	6V 12W	3.2V 10AH	6	10-12
JY-TG-400W-3	302*250*72	400W	6V 18W	3.2V 15AH	6	10-12
JY-TG-500W-3	335*270*72	500W	6V 24W	3.2V 20AH	6	10-12
JY-TG-600W-3	398*310*86	600W	6V 28W	3.2V 25AH	6	10-12



**FEATURES**

- No need wiring, easy to install
- Intelligent control with Timer, Dimming, Remote Control
- ABS body with PC lens, all in one design
- IP65 design with long lifetime of 30,000 hrs
- PIR sensing function

3000K 4000K 6500K

Remote Control Timer Control PIR Sensor

Charge by solar light during the day Automatic light up at night

CRI 80 LiFePO4 BATTERY POLYCRYSTALLINE SOLAR PANEL -10°C~+70°C Material Alu.+PC IP65

CE RoHS COMPLIANT



Model	Size L*W*H(mm)	Solar Panel	Lumen(lm)	LiFeP04 Battery	chargingtime (hrs)	Working time (hrs)
JYTO -7111	338*208*70	5V 12W	750lm	3.2V 18AH	6-8	8-12
JYTO -7112	488*208*70	5V 18W	850lm	3.2V 18AH	6-8	8-12
JYTO -7113	608*208*70	5V 22W	1250lm	3.2V 24AH	6-8	8-12

**FEATURES**

- No need wiring, easy to install
- Intelligent control with Timer, Dimming, Remote Control
- Aluminum body with PC lens, all in one design
- IP65 design with long lifetime of 30,000 hrs
- PIR sensing function can be selected

3000K 4000K 6500K

Remote Control Timer Control PIR Sensor

Charge by solar light during the day Automatic light up at night

CRI 80 LiFePO4 BATTERY POLYCRYSTALLINE SOLAR PANEL -10°C~+70°C Material Alu.+PC IP65

CE RoHS COMPLIANT



Model	Size L*W*H(mm)	Solar Panel	Lumen(lm)	LiFeP04 Battery	chargingtime (hrs)	Working time (hrs)
JYTO -7211	338*208*70	5V 12W	750lm	3.2V 18AH	6-8	8-12
JYTO -7212	488*208*70	5V 18W	850lm	3.2V 18AH	6-8	8-12
JYTO -7213	608*208*70	5V 22W	1250lm	3.2V 24AH	6-8	8-12

## FEATURES

- No need wiring, easy to install
- Intelligent control with Timer, Dimming, Remote Control
- Die-cast aluminum body with PC lens
- IP65 design with long lifetime of 30,000 hrs



3000K 4000K 6500K

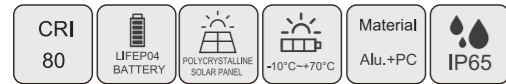

Model	Size L*W*H(mm)	Solar Panel	Lumen(lm)	LiFeP04 Battery	chargingtime (hrs)	Working time (hrs)
JYTO -7311	800*305~160	6V 30W	750lm	3.2V 24AH	6-8	8-12
JYTO -7312	940*305~160	6V 45W	1500lm	3.2V 36AH	6-8	8-12
JYTO -7313	1190*305*160	6V 60W	2250lm	3.2V 48AH	6-8	8-12

## FEATURES

- No need wiring, easy to install
- Intelligent control with Timer, Dimming, Remote Control
- Die-cast aluminum body with PC lens
- IP65 design with long lifetime of 30,000 hrs



3000K 4000K 6500K

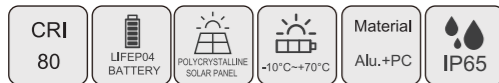

Model	Size L*W*H(mm)	Solar Panel	Lumen(lm)	LiFeP04 Battery	chargingtime (hrs)	Working time (hrs)
JYTO -7411	800*305*160	6V 30W	750lm	3.2V 24AH	6-8	8-12
JYTO -7412	940*305*160	6V 45W	1500lm	3.2V 36AH	6-8	8-12
JYTO -7413	1190*305*160	6V 60W	2250lm	3.2V 48AH	6-8	8-12

## FEATURES

- No need wiring, easy to install
- Intelligent control with Timer, Dimming, Remote Control
- Aluminum body with PC lens
- IP65 design with long lifetime of 30,000 hrs
- hybrid function can be selected for project requirement



3000K 4000K 6500K

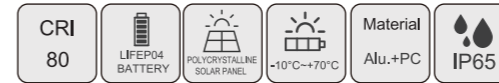

Model	Size L*W*H(mm)	Solar Panel	Lumen(lm)	LiFeP04 Battery	chargingtime (hrs)	Working time (hrs)
JYTO -7511	673*368*326	5V 60W	750lm	3.2V 100AH	"6-8	"8-12
JYTO -7512	802*368*326	5V 90W	850lm	3.2V 150AH	"6-8	"8-12

## FEATURES

- No need wiring, easy to install
- Intelligent control with Timer, Dimming, Remote Control
- Aluminum body with PC lens
- IP65 design with long lifetime of 30,000 hrs
- hybrid and camera function can be selected for project requirement



3000K 4000K 6500K



Model	Size L*W*H(mm)	Solar Panel	Lumen(lm)	LiFeP04 Battery	chargingtime (hrs)	Working time (hrs)
JYTO -7611	673*368*326	18V 36W	2700lm	12.8V 18AH	6-8	8-12
JYTO -7612	802*368*326	18V 45W	5400lm	12.8V 30AH	6-8	8-12
JYTO -7613	1157~368*326	18V 70W	7200lm	12.8V 42AH	6-8	8-12
JYTO -7614	1371*368*326	18V 100W	10800lm	25.6V 30AH	6-8	8-12
JYTO -7615	1332*538*326	18V 130W	13500lm	25.6V 36AH	6-8	8-12

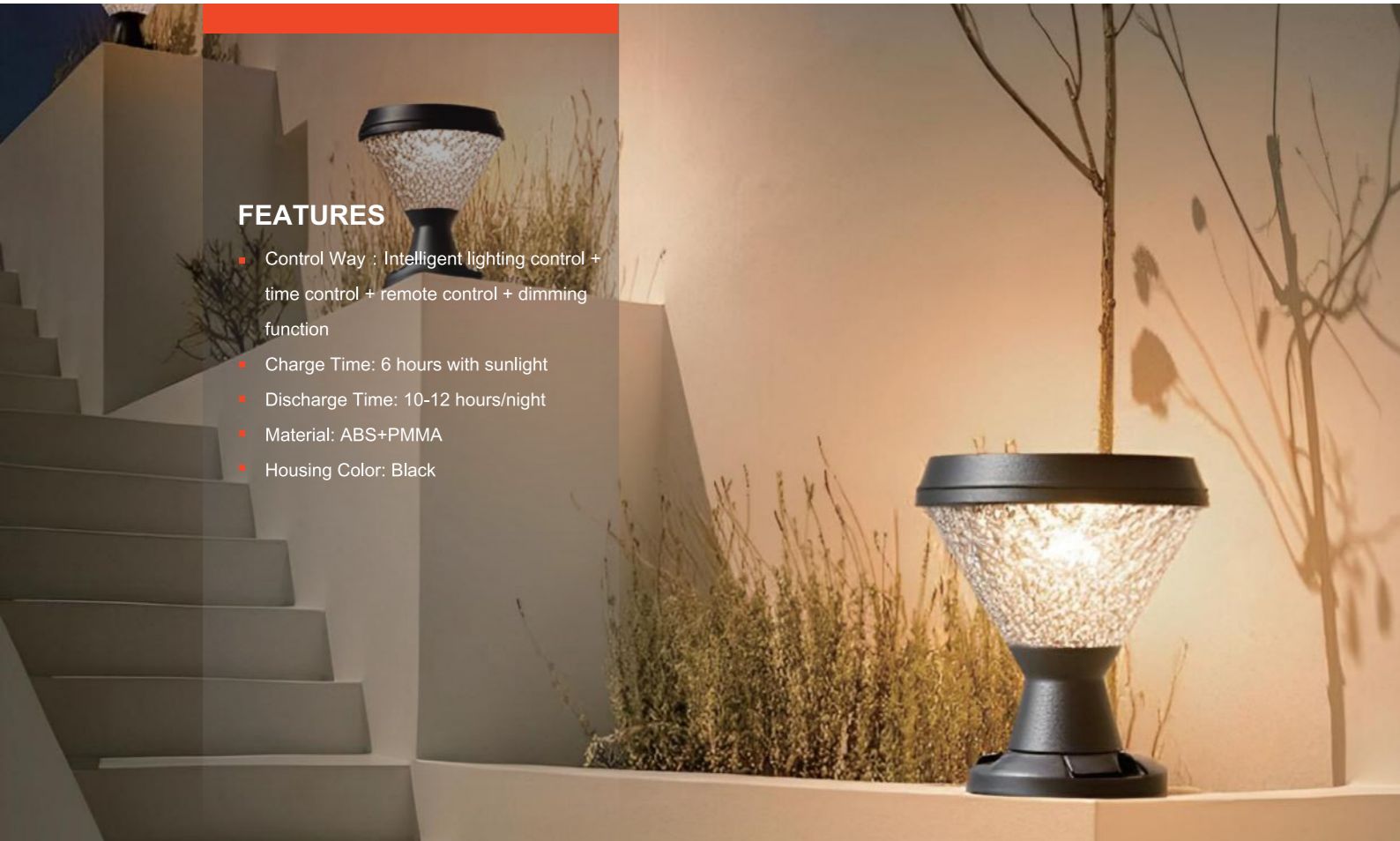

FEATURES

- Control Way : Intelligent lighting control + time control + remote control + dimming function
- Charge Time: 6 hours with sunlight
- Discharge Time: 10-12 hours/night
- Material: ABS+PMMA
- Housing Color: Black

FEATURES

- Control Way : Intelligent light control + dial-up color change + connected LED bulb + acrylic UV anti-yellow
- Charge Time: 6 hours with sunlight
- Discharge Time: 10-12 hours/night
- Material: ABS+PMMA
- Housing Color: Black



CCT : 7500K±500K



Model	Size L*W*H(mm)	Power	Solar Panel	LiFePO4 Battery	chargingtime (hrs)	Working time (hrs)
JY-SL-SQ-100W-1	240*168*55	100W	5V 6W	3.2V 5AH	6	10-12
JY-SL-SQ-200W-1	280*198*55	200W	5V 12W	3.2V 10AH	6	10-12
JY-SL-SQ-300W-1	330*238*55	300W	5V 18W	3.2V 15AH	6	10-12
JY-SL-SQ-400W-1	390*288*60	400W	5V 24W	3.2V 20AH	6	10-12

FEATURES

- Control Way : Intelligent lighting control + time control + remote control + dimming function
- Charge Time: 6 hours with sunlight
- Discharge Time: 10-12 hours/night
- Material: ABS+PMMA
- Housing Color: Black



CCT : 7500K±500K

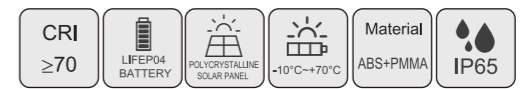

Model	Size L*W*H(mm)	Power	Solar Panel	LiFePO4 Battery	chargingtime (hrs)	Working time (hrs)
JY-SL-BD-30W-1	245*245*230	30W	6V 4.5W	3.7V 3.6AH	6	10-12
JY-SL-BD-30W-2	225*225*250	30W	6V 4.5W	3.7V 3.6AH	6	10-12



CCT : 7500K±500K



Model	Size L*W*H(mm)	Power	Solar Panel	LiFePO4 Battery	chargingtime (hrs)	Working time (hrs)
JY-SL-30W-1	245*245*270	30W	6V 4.5W	3.7V 3.6AH	6	10-12
JY-SL-30W-2	225*225*280	30W	6V 4.5W	3.7V 3.6AH	6	10-12