

PVC FLAME-RESISTING WIRE TRUNKING AND CONDUIT

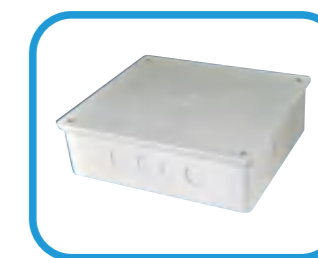

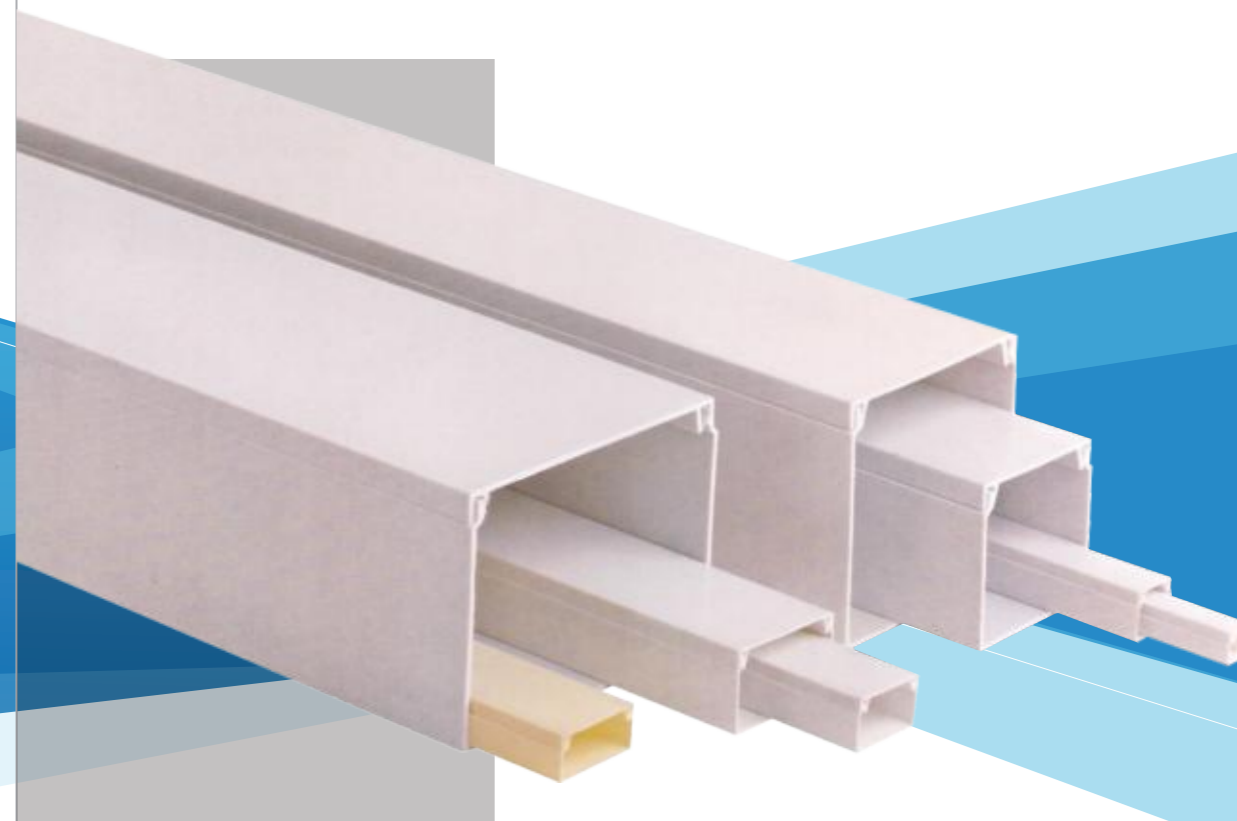

科技驱动，砥砺前行

公司简介 Company Introduction



佛山市索达山新材料科技有限公司位于中国广东省佛山市，拥有超过15年的管道销售经验。我们的ULP工厂地理位置优越，靠近南沙、高明和深圳港口，确保货物运输快速便捷。

工厂占地10000多平方米，拥有100多名员工，并配有专业的技术和质检团队。月产能超过1000万件，我们还提供OEM/ODM服务和工厂检验服务。ULP已获得ISO 9000、ETL、CE和SGS认证。我们的主要市场包括北美、南美、东南亚、中东、非洲等。

Foshan SDSH Material Technology Co., Ltd. has over 15 years of experience in pipeline sales and is located in Foshan, Guangdong Province, China. Our ULP factory is strategically close to Nansha, Gaoming, and Shenzhen ports, ensuring fast and convenient shipment of goods.

The factory covers an area of more than 10,000 square meters and employs over 100 staff members, supported by a professional technical and quality inspection team. With a monthly production capacity exceeding 10 million pieces, we also provide OEM/ODM services and factory inspection services.

ULP has obtained ISO 9000, ETL, CE, and SGS certifications. Our primary markets include North America, South America, Southeast Asia, the Middle East, Africa, and more.

荣誉证书 Honor Certificate

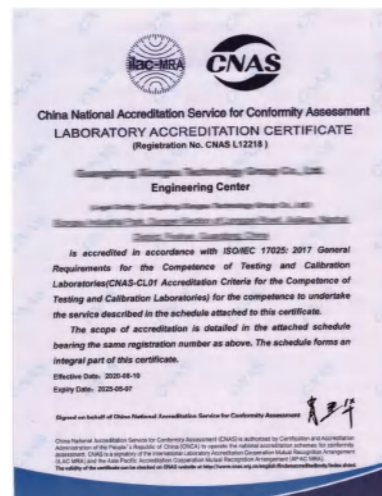

PE泡棉胶带/PE Foam Tape

产品描述: PE泡棉胶带以PE泡棉为基材，双面涂布压克力胶水，再贴合离型材料制作而成。

胶带厚度: 0.15-5MM

泡棉颜色: 黑白灰

离型材料: 红/绿/蓝膜 白纸 黄纸 格拉辛纸

Descriptions: PE foam tape combines PE foam as the carrier with acrylic solvent based adhesive that provides high initial tack and holding power to a wide variety of surfaces.

Tape thickness with out liner: 0.15mm-5mm

Foam color: Black White Grey

Liner: Red/green/blue poly film white/yellow paper glassine paper

普通密度PE泡棉双面胶带

产品型号 Item No.	基材 Carrier	胶水 Adhesive	厚度 Thickness (mm)	密度 Density	初粘力 Initial Tack (N/25mm)	粘着力 Adhesion to steel(N/25mm)	持粘力 Holding Power (hour)	耐温 Heat resistance(°C)	备注 Remark
4108W/B	PE泡棉PE foam	丙烯酸 Solvent acrylic	0.8	普通密度	24	26	≥48	100	红膜白/黑PE0.8T
4210W/B	PE泡棉PE foam	丙烯酸 Solvent acrylic	1.0	普通密度	24	26	≥48	100	绿膜白/黑PE1.0T
4315W/B	PE泡棉PE foam	丙烯酸 Solvent acrylic	1.5	普通密度	24	26	≥48	100	蓝膜白/黑PE1.5T
4620W/B	PE泡棉PE foam	丙烯酸 Solvent acrylic	2.0	普通密度	24	26	≥48	100	白纸白/黑PE2.0T
4730W/B	PE泡棉PE foam	丙烯酸 Solvent acrylic	3.0	普通密度	24	26	≥48	100	黄纸白/黑PE3.0T



高密度PE泡棉双面胶

产品型号 Item No.	基材 Carrier	胶水 Adhesive	厚度 Thickness (mm)	密度 Density	初粘力 Initial Tack (N/25mm)	粘着力 Adhesion to steel(N/25mm)	持粘力 Holding Power (hour)	耐温 Heat resistance(°C)	备注 Remark
5105W/B	PE泡棉PE foam	丙烯酸 Solvent acrylic	0.5	高密度	20	22	≥72	120	红膜白/黑PE0.5T
5208W/B	PE泡棉PE foam	丙烯酸 Solvent acrylic	0.8	高密度	20	22	≥72	120	绿膜白/黑PE0.8T
5310W/B	PE泡棉PE foam	丙烯酸 Solvent acrylic	1.0	高密度	20	22	≥72	120	蓝膜白/黑PE1.0T
5415W/B	PE泡棉PE foam	丙烯酸 Solvent acrylic	1.5	高密度	20	22	≥72	120	白纸白/黑PE1.5T

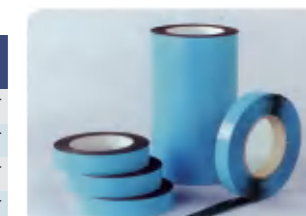

标准尺寸 (Standard Dimention)	宽度 (Width)	长度 (Length)
可按需分切 ≥3mm	1040mm	50m
Widths ≥3mm are available as customers requirements.		

型号说明: 4系列为普通密度泡棉, 5系列为高密度泡棉, 6系列为超薄泡棉; 第二个数字: 1=红膜 2=绿膜 3=蓝膜 6=白纸 7=黄纸; 末尾2位数字表示厚度; W=白色 B=黑色 G=灰色。

实例: 4110B代表: 红膜普通密度黑色1.0mm PE泡棉胶带。

压克力泡棉双面胶带系列 / Acrylic Foam(VHB)Tape

产品描述: 压克力VHB胶带凭借其在持久粘合和密封多种基材应用中的高效率、高强度、高耐候及美观性，在全球工业界得到广泛应用。成功案例：汽车结构应用、玻璃幕墙应用、广告标牌、电子装配等。

Descriptions: Acrylic foam tapes are designed to provide very high bond strength to a variety of substrates. Applied to replace mechaical fasteners in appliance, automotive, signs, graphics, glass curatin wall attachment and other manufacturing applications.

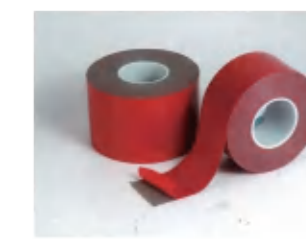

产品型号 Item No.	基材 Carrier	胶水 Adhesive	厚度 Thickness (mm)	颜色 Color	粘着力 Adhesion to steel(N/25mm)	抗拉强度 Tensile Strength (gf/cm2)	持粘力80°C Holding power(hour)	耐温 Heat resistance(°C)
8025G/W	压克力泡棉 Acrylic foam	丙烯酸 Solvent acrylic	0.25	灰色/白色 Grey/White	≥3500	≥8500	≥24	150
8040G/W	压克力泡棉 Acrylic foam	丙烯酸 Solvent acrylic	0.4	灰色/白色 Grey/White	≥3500	≥8500	≥24	150
8080G/W	压克力泡棉 Acrylic foam	丙烯酸 Solvent acrylic	0.8	灰色/白色 Grey/White	≥4000	≥7000	≥24	150
8012G/W	压克力泡棉 Acrylic foam	丙烯酸 Solvent acrylic	1.2	灰色/白色 Grey/White	≥4500	≥6500	≥24	150
8220G/W	压克力泡棉 Acrylic foam	丙烯酸 Solvent acrylic	2	灰色/白色 Grey/White	≥4500	≥5500	≥24	150
8050C	压克力泡棉 Acrylic foam	丙烯酸 Solvent acrylic	0.5	透明 Clear	≥3500	≥7500	≥24	150
8100C	压克力泡棉 Acrylic foam	丙烯酸 Solvent acrylic	1	透明 Clear	≥4000	≥6500	≥24	150

标准尺寸 (Standard Dimention)	宽度 (Width)	长度 (Length)
可按需分切 ≥3mm	8400mm	330m
Widths ≥3mm are available as customers requirements.		

注: 本资料数据为产品测试的普通值，不代表每个产品的实际值。Note: Information in above sheet is average values for the test we believe to be reliable, there of is not guaranteed. It is for customers reference only.

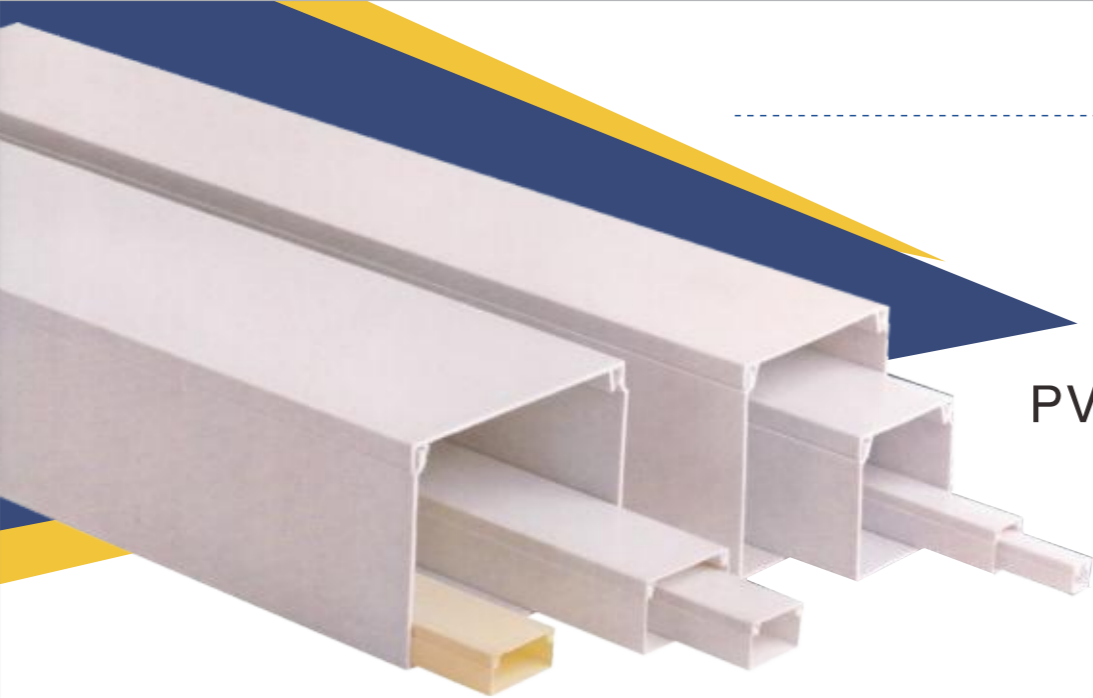

<<< PVC CABLE TRUNKING PVC难燃电线槽系列

产品说明

产品材质: 全新料硬质PVC料制成

产品认证: 欧洲CE, 欧洲环保RoHS

防火等级: FV-0级; FH-1。遇火不燃烧, 防火性及绝缘性特佳

结构: 由线槽托架和盖子组成

工作温度: 静态-40℃持续高温至65℃

颜色: 广泛使用白色, 蓝白, 象牙白。可以调其他颜色 (有最少量要求)

特点: 1.防火性好, 绝缘性高, 能够抵抗25千伏电压; 耐高温, 高温后不容易变形, 不影响电线的排布, 对电线以及整个电路装置起到一个很好的保护作用。

2.密封式的设计可以更好地防尘, 防鼠, 外形美观。

3.线槽有强度韧性, 耐燃, 防火, 防潮, 耐微碱性, 耐老化。

4.安装方便: 重量轻, 易于切割、运输、弯曲、和处理, 易于用粘合剂无渗漏地连接。

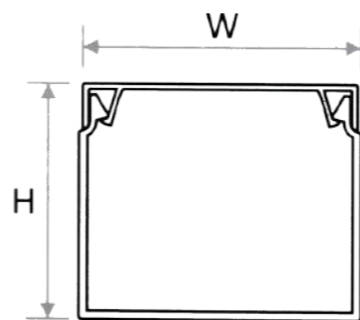

备注: 底部可以做带黏贴性

PVC CABLE TRUNKING

Material: Made of rigid PVC

Certificates: CE (Test Staandard: EN50085); RoHS

Flammability Rating: FV-0; FH-1

Struction: Made up of duct bottom and cover

Application: Used in stage, electric apparatus, air conditioning or indoors

Work Temperature: -40℃ to -65℃

Available Color: Ivory, snow white, bluish white, other color need more MOQ

Feature: 1.Non-conductive: good insulation, able to resist25KV voltage, assuring a safe system

2.Solid design, especially for anti-dust and anti-mouse

3.Trunkings have strength tenacity, and are combustion-proof, fireproofing, dampproof, alkalescency-resistant, aging-resistant

4.Easy Installation: light weight, easy to cut, transport, bent and handle;easy connecting by solvent cement and threading joining without leakage

5.Mini-Trunking has been designed to match in with both the square andradius cornered surface mounted switch and socket boxes

COMMENT: We can make it to be adhesive trunking.



PARAMETER / 参数 单位/Unit:mm

Item.No.型号	W x H	Thickness	Item.No.型号	W x H	Thickness
YS-1010	10x10	0.6	Ys-6022	60x22	0.85/1.1
YS-1212	12x12	0.6	YS-6040	60x40	1.2/1.4
YS-1510	15x10	0.58/0.7/0.9	YS-6060	60x60	1.2/1.55
YS-1616	16x16	0.58/0.65/0.85/1.0/1.1	YS-7550	75x50	1.2/1.45/1.75
YS-1809	18x9	0.58/0.68	YS-7575	75x75	1.3/1.6/1.75
YS-2010	20x10	0.55/0.65/0.75/0.85/0.95	YS-8040	80x40	1.4
YS-2212	22x12	0.5/0.6/0.7	YS-8050	80x50	1.6
YS-2414	24x14	0.65/0.7/0.8/1.0	YS-10027	100x27	1.2/1.5
YS-2516	25x16	0.58/0.63/0.65/0.75/0.95/1.1/1.2	YS-10040	100x40	1.4/1.7
YS-2525	25x25	0.75/0.85	YS-10050	100x50	1.35/1.7/2.2
YS-3015	30x15	0.6/0.7/0.85/1.0	YS-10060	100x60	1.4/1.7
YS-3816	38x16	0.58/0.65/0.85/1.2/1.3	YS-10075	100x75	1.5/1.65/1.8
YS3919	39x19	0.8/0.9/1.0/1.2	YS-100100	100x100	1.6/2.0/2.3
YS-4016	40x16	1.2	YS-12060	120x60	2.0
YS-4025	40x25	0.68/0.8/0.85/1.0	YS-12080	120x80	2.0
YS-4040	40x40	1.0	YS-15050	150x50	2.3
YS-5025	50x25	1.2/1.8	YS-150100	150x100	2.0
YS-5050	50x50	1.1/1.35/1.5	YS-200100	200x100	2.4

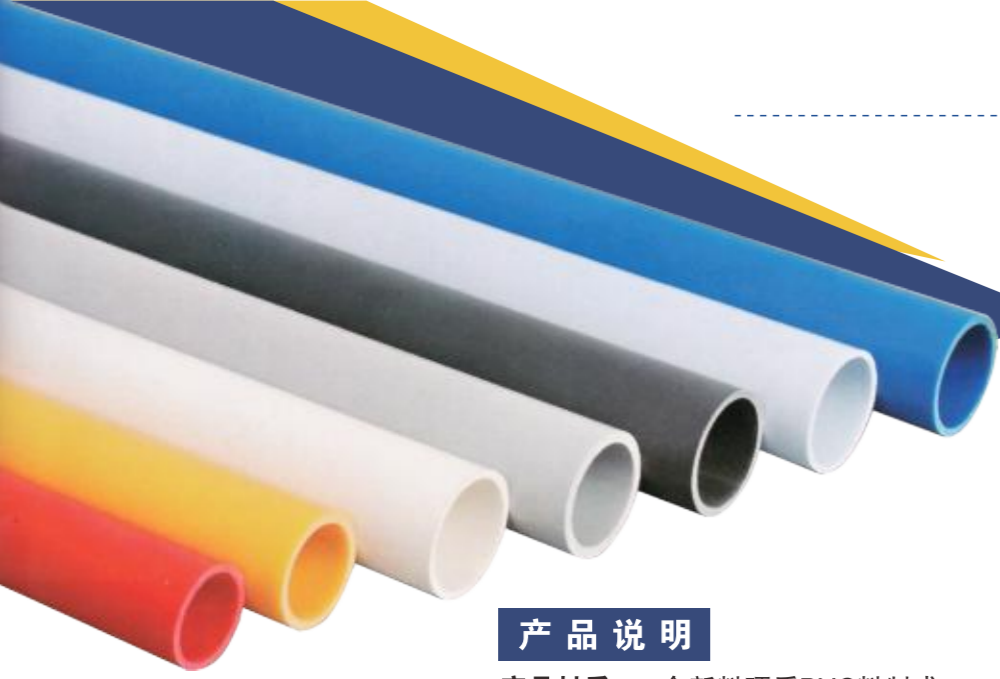

<<< PVC ELECTRICAL PIPE PVC难燃电线槽系列

产品说明

- 产品材质:** 全新料硬质PVC料制成
产品认证: 欧洲CE, 欧洲环保RoHS
防火等级: FV-0级; FH-1。遇火不燃烧, 防火性及绝缘性特佳
工作温度: 静态-40℃持续高温至65℃
颜色: 广泛使用白色, 蓝白, 象牙白。可以调其他颜色 (有最少量要求)
特点: 1.耐腐蚀性能: 抗酸、碱和盐, 保证较低的维护成本, 较长使用寿命
 2.穿线管有强度韧性, 耐燃, 防火, 防潮, 耐微碱性, 耐老化
 3.强冲击强度: 抗压缩和冲击, 适合被埋在混凝土

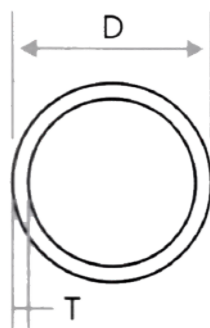

PARAMETER / 参数 单位/Unit:mm

Item.NO.型号	Specification 外径	Thickness 厚度	Packing (pcs/bag) 包装 (条/扎)
YS-16W	Φ16	0.8/0.9/1.0/1.1/1.2	30
YS-20W	Φ20	0.9/1.0/1.1/1.2/1.35/1.6	25
YS-25W	Φ25	1.0/1.1/1.2/1.3/1.4/1.6/1.8	20
YS-32W	Φ32	1.2/1.3/1.4/1.5/1.6/1.8	10
YS-40w	Φ40	1.1/1.2/1.3/1.4/1.5/1.6/1.8/2.0	10
YS-50W	Φ50	1.3/1.4/1.5/1.6/1.8/1.9/2.2	5

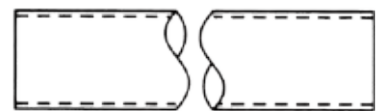

质量测试范围:

操作过程: 首先选取与管径配套的弹簧, 然后把弹簧插入到线管需要弯曲的位置, 用手弯曲线管即可。

效果: 线管可以随意弯曲到180°不会爆裂。

冷弯管的好处: 当线管用于墙壁角落布线时, 可直接弯曲线管, 不用管弯头。



Quality Test:

Operation: Choose a spring fit with the size of PVC PIPE. Curve the pipe after inserting spring at the place of pipe where you need it be bent.

Effect: PVC PIPE can be bent from 5° to 180° without broken.

Advantage: Client can bend the pipe at the corner without using elbow.



PVC >>> ELECTRICAL FLARED PIPE PVC难燃扩口电线管



PVC ELECTRICAL PIPE

- Material:** Made of rigid PVC
Certificates: CE (Test Standard : En61386); RoHS
Flammability Rating: FV-0; FH-1
Work Temperature: -40℃ to -65℃
Available Color: Ivory, snow white, bluish white, other color need more MOQ.
Feature: 1. Corrosion Resistance: resistant to acids, bases and salts, assuring a lower maintenance cost and a longer performance life
 2. PVC PIPE trunkings have strength tenacity, and are combustion-proof, fireproofing, dampproof, alkalescency-resistant to compression and impact, suitable to be buried in concrete

PARAMETER / 参数 单位/Unit:mm

Item.NO.型号	d	D	Thickness 厚度	Packing (pcs/bag) 包装 (条/扎)
	细外径	宽口直径		
YSL-16W	Φ16	Φ18.6	0.8/0.9/1.0/1.1/1.2	30
YSL-20W	Φ20	Φ22.5	0.9/1.0/1.1/1.2/1.35	25
YSL-25W	Φ25	Φ27.5	1.0/1.1/1.2/1.3/1.4/1.6	20
YSL-32W	Φ32	Φ34.5	1.2/1.3/1.4/1.5/1.6	10

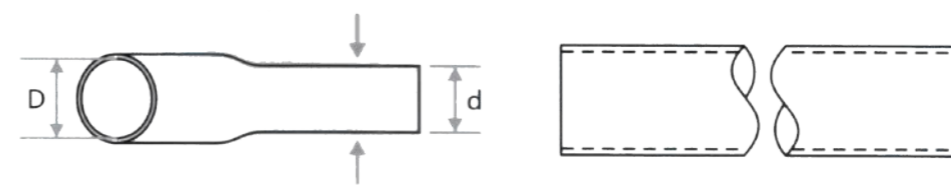

配件 ACCESSORIES

线管配件
PVC Pipe Accessories

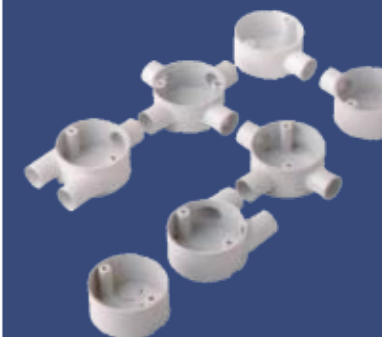
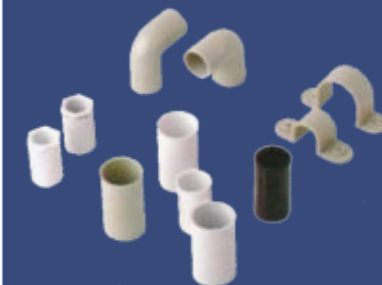

<<< PVC

ACT FLOOR CABLE TRAY

PVC 弧形线槽

产品说明

- 产品材质:** 采用硬质PVC料制成
产品认证: 欧洲CE, 欧洲环保RoHS
防火等级: FV-0级; FH-1。遇火不燃烧, 防火性及绝缘性特佳
产品构造: 有槽底和槽盖组成, 槽底可以附双面胶
工作温度: -40℃持续高温至80℃
颜色种类: 白色, 米白色, 灰色。其他颜色接受定做。
使用方法: 将地板擦干净后, 再将地槽双面胶撕开, 黏贴固定于地板上, 随后装入电线, 盖上槽盖即可。

- 特点:**
1. 圆弧槽盖造型设计, 有美观及抗重压之功能, 不绊倒人及更易于搬运车通过。
 2. 配线槽85℃内不易断裂, 变形, 变色, 装配省时便利。
 3. 密封式无出线孔, 能防尘, 防鼠, 适用于工程施工及建厂之导线或配明线用。

长度说明: 默认出货为2米。其他长度可定做。

PRODUCT DESCRIPTION

- ▶ Backed with high quality double sided tape for permanent fixture
- ▶ Good for floor wiring to facilitate trolley pass and to avoid tripping, especially in public places, like shopping malls, hospitals, and stations.
- ▶ Material: PVC
- ▶ The bottom of duct can be stuck with DOUBLE - COATED FOAM TAPE then fasten on the floor easily.
- ▶ Length: 2m
- ▶ Color: White, Yellow and Grey. Other color need more MOQ

PARAMETER / 参数 单位/Unit:mm

Item.NO. 型号	Size 尺寸		Thickness 厚度	Packing(pcs/bag) 包装(条/扎)
	W 底宽	H 高度		
YSH-25x8	25	8	1.25	30
YSH-35x10	35	10	1.4	30
YSH-50x15-1	50	15	1.3	20
YSH-50x15-2	50	15	1.8	20
YSH-70x20-1	70	20	1.5	10
YSH-70x20-2	70	20	2.1	10
YSH-100x30	100	30	2.3	10

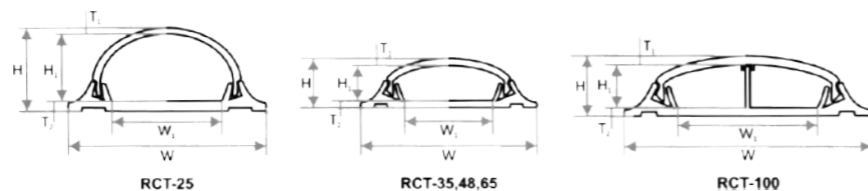

PVC >>>

COMPARTMENT TRUNKING

难燃分隔式难燃线槽

产品说明

PVC-U型分隔式线槽属于广泛被采用的深度50mm系列大线槽, 适用于安装规格大, 数量多的电线。
 有两种不同的宽度: 180mm和100mm
 灵活滑动盖设计, 方便安装电线和开关盒。
 有效灵活地把电线按需分隔。

PRODUCT DESCRIPTION

Compartment PVC-U is an attractive 50mm deep trunking system for large quantities of cable.

- ▶ Available in two widths - 180mm and 100mm
- ▶ Slip lid
- ▶ Extra deep accessory boxes
- ▶ Segregation available into four compartments

简易分拆式 SIMPLE SPLIT TYPE

PARAMETER / 参数

Item.NO. 型号	Size 尺寸(mm)		Thickness 厚度(mm)	Remark 备注	Packing(pcs/bag) 包装(条/扎)
	W 宽度	H 高度			
YSG-50	50	25	2 spacers	1.3	10
YSG-100	100	50	2/3 spacers	1.7	6
YSG-150	150	50	2/3 spacers	1.9	4

Special Charistic: Trunking can be divided into three or four compartments using clip-in dividing fillet.
 产品特性: 把区间通过间隔片平均划分成3-4个间隔, 也可以选择性按需要插入挡片。

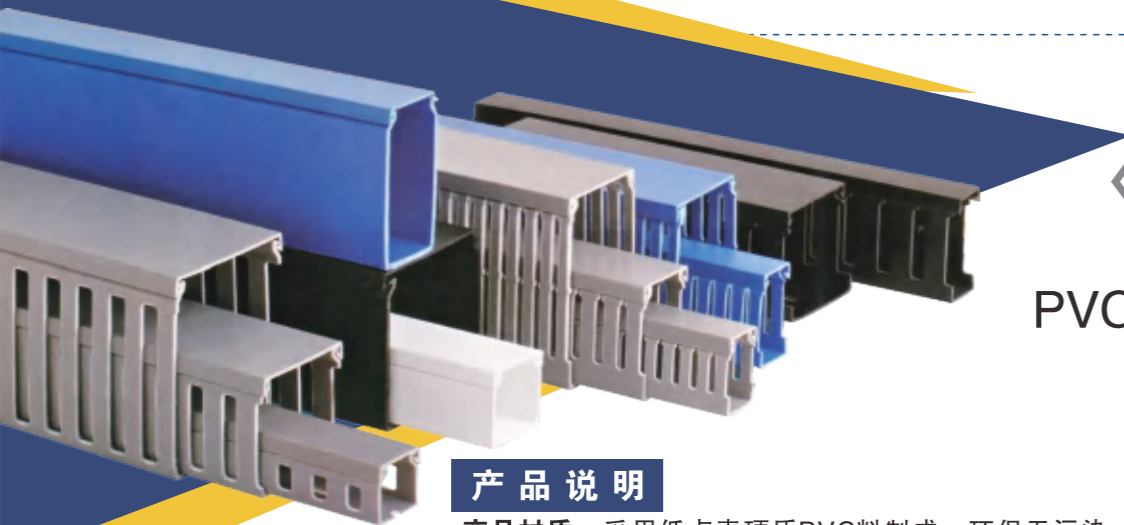

<<< PVC WIRING DUCT PVC环保阻燃行线槽

产品说明

- 产品材质:** 采用低卤素硬质PVC料制成, 环保无污染, 不含铅等有害物质。
产品认证: 美国UL: E306674; 欧洲CE, 欧洲环保RoHS, REACH.
防火等级: UL94V-0, 低烟微卤, 遇火不燃烧, 防火性及绝缘性特佳。
产品构造: 有槽底和槽盖组成。
工作温度: 静态-40℃持续高温至70℃。
颜色各类: 灰色, 白色, 蓝色, 黑色, (灰色为常规库存产品, 其他颜色有起订量要求)
使用方法: 先将底槽固定, 将所有配的线装入槽内, 盖上槽盖即可。
产品种类: 1.开孔型(A): 由槽底及槽盖组成, 底槽两侧设有多种不同宽度的出线孔。
 特性: (1) 反扣式槽盖与槽体设计组合后绝不脱落, 且结合面平滑, 不割伤手及磨损附近配线。
 (2) 配线槽70℃内不易断裂, 变形, 变色, 装配省时便利。
 (3) 出线孔低, 易折断型。内部两侧带折痕设计, 可依安装者需求, 折出需求的边孔大小。
 2.连齿型(B): 由槽底及槽盖组成, 底槽两侧设有多种不同宽度的出线孔。
 特性: 顶部连体开孔设计, 方便盖子组合, 加快线槽的组装时间。
 3.密封性(C): 反扣式槽盖与槽体设计组合后防运输振动导致滑落, 防
 线槽垂直安装时滑盖。
 特性: 密封式的设计可以更好地防尘, 防鼠, 外形美观。

PRODUCT DESCRIPTION

Made of rigid PVC
 Certificates: UL:E306674 CE:EN50085 RoHS, REACH.
 UL Recognized continuous use temperature: 50°C (122°F)
 UL94 Flammability Rating of V-0
 Available Colors: gray is the common color, other color need more MOQ
 Work Temperature: -40°C to 65°C
 The ingenious clip-on lid is easily removed by the contractor for maintenance or alteration of the cabling system.

Different Model:

1.Slot Wiring Duct(A):
 Europe standard Wide slot/finger design provides greater sidewall rigidity nad can be used with a wide range of wire bundle sizes.
 This style is also wide used in Japan and Korea.
 Provided with mounting holes.
 Duct and cover packaged together in 2 meter lengths.
 Special design: with score line at the base of trunking,it makes the fingers easy to separate form the trunking no need to us cutter.

2.Wide Close Slot Wiring Duct(B)

Solid design on top wall
 Convenient to over, Speed wire installation

3.Solid Wiring Duct(C)

- Made of halogen free material and verified with IEC 60754-2 test method (test on gases evolved during combustion of electric cables)
- Solid wall design fully encloses cables providing maximum protection and aesthetics.
- Without slot in the wall
- Without providing mounting holes
- Duct and cover packaged together in 2 meter lengths

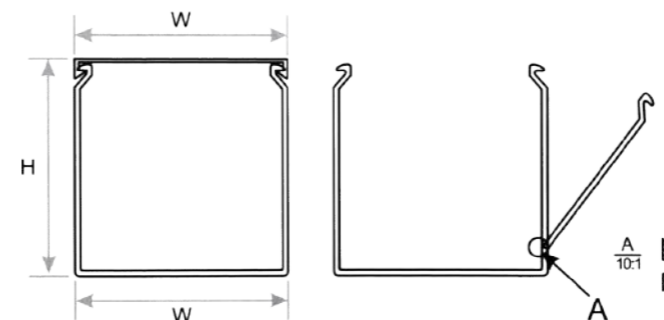

样式: 16mm-75mm宽(height) 样式: 80mm-130mm宽(height)

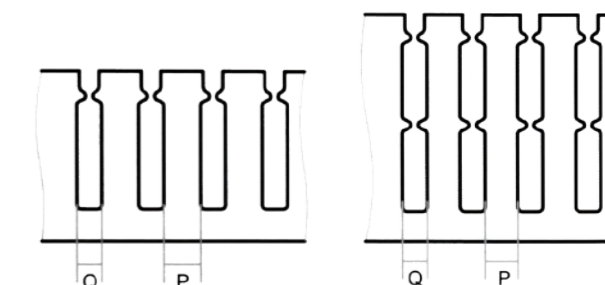

样式: 16mm-75mm宽(width)

PARAMETER / 参数 单位/Unit:mm

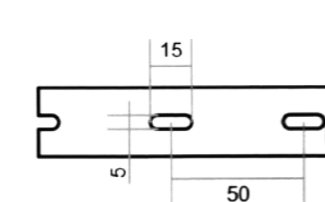

默认底孔单排孔/Common hole

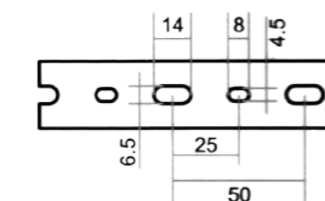

可定制大小孔/Eu Hole pf DIN43 659

样式: 80mm-100mm宽(width)

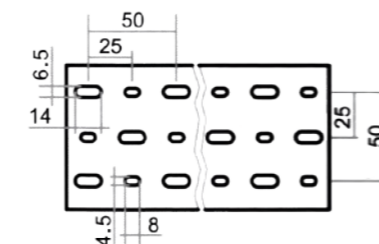

样式: 120mm-200mm宽(width)

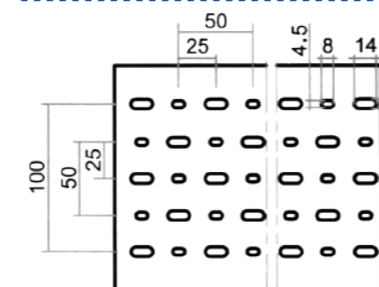

Item.No. 型号	W x H	Thickness 厚度	Item.No. 型号	W x H	Thickness 厚度
YSF-2015	20x15	1.3	YSF-5050	50x50	1.6
YSF-2020	20x20	1.3	YSF-5055	50x55	1.6
YSF-2525	25x25	1.4	YSF-5080	50x80	1.8
YSF-2550	25x50	1.6	YSF-6025	60x25	1.3
YSF-3025	30x25	1.4	YSF-6030	60x35	1.4
YSF-3030	30x30	1.5	YSF-6040	60x40	1.6
YSF-3040	30x40	1.6	YSF-6060	60x60	2
YSF-3530	35x30	1.4	YSF-60100	60x100	2
YSF-3535	35x35	1.4	YSF-6525	65x25	1.3
YSF-4030	40x30	1.4	YSF6532	65x32	1.4
YSF-4035	40x35	1.4	YSF-6545	65x45	1.6
YSF-4040	40x40	1.4	YSF-6565	65x65	1.6
YSF-4525	45x25	1.4	YSF-8030	80x30	1.8
YSF-4532	45x32	1.4	YSF-8040	80x40	2.0
YSF-4545	45x45	1.5	YSF-8050	80x50	2.0
YSF-5025	50x25	1.6	YSF-8080	80x80	2.0
YSF-5030	50x30	1.6	YSF-80100	80x100	2.0
YSF-5035	50x35	1.6	YSF-10060	100x60	2.0
YSF-5045	50x45	1.6	YSF-100100	100x100	2.2

Electrical Accessories Series



ITEM NO.:	MA001
PRODUCT NAME:	3" X 3" Thick Switch Box
SIZE:	86x86x32
QTY/CTN (PCS):	20/200
CARTON SIZE:	84.5x19x37.5
NUT SIZE:	M3.5



ITEM NO.:	MA007
PRODUCT NAME:	3" X 3" Switch Box
SIZE:	72x72x38
QTY/CTN (PCS):	100
CARTON SIZE:	39.5x31.5x21
NUT SIZE:	M3.5



ITEM NO.:	MA002
PRODUCT NAME:	3" X 6" Thick Switch Box
SIZE:	148x88x32
QTY/CTN (PCS):	20/200
CARTON SIZE:	88x31x37.5
NUT SIZE:	M3.5



ITEM NO.:	MA008
PRODUCT NAME:	3" X 6" Switch Box
SIZE:	132x72x37
QTY/CTN (PCS):	100
CARTON SIZE:	38.5x38.5x28
NUT SIZE:	M3.5



ITEM NO.:	MA003
PRODUCT NAME:	3" X 3" Thin Switch Box
SIZE:	86x86x32
QTY/CTN (PCS):	20/200
CARTON SIZE:	84.5x19x37.5
NUT SIZE:	M3.5



ITEM NO.:	MA009
PRODUCT NAME:	3" X 3" PS Switch Box
SIZE:	86x86x32
QTY/CTN (PCS):	100
CARTON SIZE:	84.5x19x37.5
NUT SIZE:	M3.5



ITEM NO.:	MA004
PRODUCT NAME:	3" X 6" Thin Switch Box
SIZE:	148x88x32
QTY/CTN (PCS):	20/200
CARTON SIZE:	88x31x37.5
NUT SIZE:	M3.5



ITEM NO.:	MA011
PRODUCT NAME:	Double Male Bush
SIZE:	φ 20
QTY/CTN (PCS):	1000
CARTON SIZE:	48/30.5/31.5
NUT SIZE:	



ITEM NO.:	MA005
PRODUCT NAME:	3" X 3" Switch Box
SIZE:	78x78x40
QTY/CTN (PCS):	100
CARTON SIZE:	38.5x38.5x20.7
NUT SIZE:	M3.5



ITEM NO.:	MA012
PRODUCT NAME:	Male Bush
SIZE:	φ 25
QTY/CTN (PCS):	1000
CARTON SIZE:	
NUT SIZE:	



ITEM NO.:	MA006
PRODUCT NAME:	3" X 6" Switch Box
SIZE:	137x78x40
QTY/CTN (PCS):	100
CARTON SIZE:	49x37.5x40
NUT SIZE:	M3.5



ITEM NO.:	MA012
PRODUCT NAME:	Male Bush
SIZE:	φ 25
QTY/CTN (PCS):	1000
CARTON SIZE:	
NUT SIZE:	



ITEM NO.:	SA001
PRODUCT NAME:	4" X 2" Cavity Box
SIZE:	103x58x50
QTY/CTN (PCS):	200
CARTON SIZE:	60.5x42.5x26.5
NUT SIZE:	M3.5/M5

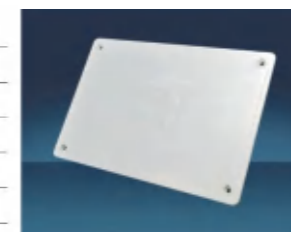

ITEM NO.:	SA007
PRODUCT NAME:	4" X 2" Cover
SIZE:	107x67x2
QTY/CTN (PCS):	500
CARTON SIZE:	36x22.5x13.5
NUT SIZE:	M3.5/M5



ITEM NO.:	SA002
PRODUCT NAME:	4" X 4" Cavity Box
SIZE:	108x108x54
QTY/CTN (PCS):	100
CARTON SIZE:	55.3x44.5x29
NUT SIZE:	M3.5/M5



ITEM NO.:	SA009
PRODUCT NAME:	4" X 4" Cover
SIZE:	112x112x2
QTY/CTN (PCS):	300
CARTON SIZE:	35.5x23x13.5
NUT SIZE:	M3.5/M5



ITEM NO.:	SA004
PRODUCT NAME:	120x120x56 Cavity Box
SIZE:	120x120x56
QTY/CTN (PCS):	80
CARTON SIZE:	51x51x29
NUT SIZE:	M3.5/M4/M5



ITEM NO.:	SA010
PRODUCT NAME:	120x120x2 Cover
SIZE:	120x120x2
QTY/CTN (PCS):	300
CARTON SIZE:	45.5x26.5x13.5
NUT SIZE:	M3.5/M5



ITEM NO.:	SA005
PRODUCT NAME:	120x120x80 Switch Box
SIZE:	120x120x80
QTY/CTN (PCS):	50
CARTON SIZE:	62x25x26
NUT SIZE:	M3.5/M5



ITEM NO.:	SA014
PRODUCT NAME:	Male Bush
SIZE:	φ 20
QTY/CTN (PCS):	100/2000
CARTON SIZE:	50.5x25x42
NUT SIZE:	



ITEM NO.:	SA006
PRODUCT NAME:	155x155x80 Switch Box
SIZE:	155x155x80
QTY/CTN (PCS):	30
CARTON SIZE:	82.5x32.5x27
NUT SIZE:	M3.5/M5



ITEM NO.	PRODUCT NAME	SIZE	QTY/CTN (PCS)	CARTON SIZE
SA015	Male Bush	φ 20	100/2000	50.5x25x42
		φ 25	100/1000	48x30.5x31.5
		φ 32	100/500	41.5x42.5x21.7

Electrical Accessories Series



型号 Code	CA001
产品名称 Name	86x86x33
产品尺寸 Size	86x86x33 (mm)
装箱数 Pcs/Ctn	200 (pcs)
纸箱尺寸 Ctn Size	45x36x35.5 (cm)
螺母规格 Nut Size	M3.5/M4



型号 Code	CA007
产品名称 Name	75x75x38
产品尺寸 Size	75x75x38 (mm)
装箱数 Pcs/Ctn	90 (pcs)
纸箱尺寸 Ctn Size	43.5x28.5x19 (cm)
螺母规格 Nut Size	M3.5/M4



型号 Code	CA002
产品名称 Name	174x86x33
产品尺寸 Size	174x86x33 (mm)
装箱数 Pcs/Ctn	100 (pcs)
纸箱尺寸 Ctn Size	54x35x36 (cm)
螺母规格 Nut Size	M3.5/M4



型号 Code	CA008
产品名称 Name	75x75x50
产品尺寸 Size	75x75x50 (mm)
装箱数 Pcs/Ctn	100 (pcs)
纸箱尺寸 Ctn Size	40.5x40.5x25 (cm)
螺母规格 Nut Size	M3.5/M4



型号 Code	CA003
产品名称 Name	258X86X35
产品尺寸 Size	258X86X35 (mm)
装箱数 Pcs/Ctn	72 (pcs)
纸箱尺寸 Ctn Size	54x27x47 (cm)
螺母规格 Nut Size	M3.5/M4



型号 Code	CA009
产品名称 Name	75x75x55
产品尺寸 Size	75x75x55 (mm)
装箱数 Pcs/Ctn	100 (pcs)
纸箱尺寸 Ctn Size	55.5x23.5x23 (cm)
螺母规格 Nut Size	M3.5/M4



型号 Code	CA004
产品名称 Name	86x86x45
产品尺寸 Size	86x86x45 (mm)
装箱数 Pcs/Ctn	90 (pcs)
纸箱尺寸 Ctn Size	45.5x35x22.5 (cm)
螺母规格 Nut Size	M3.5/M4



型号 Code	CA010
产品名称 Name	75x75x65
产品尺寸 Size	75x75x65 (mm)
装箱数 Pcs/Ctn	50 (pcs)
纸箱尺寸 Ctn Size	62x23x44 (cm)
螺母规格 Nut Size	M3.5/M4



型号 Code	CA005
产品名称 Name	79x79x39
产品尺寸 Size	79x79x39 (mm)
装箱数 Pcs/Ctn	100 (pcs)
纸箱尺寸 Ctn Size	42x23x20.5 (cm)
螺母规格 Nut Size	M3.5/M4



型号 Code	CA011
产品名称 Name	168x78x38
产品尺寸 Size	168x78x38 (mm)
装箱数 Pcs/Ctn	100 (pcs)
纸箱尺寸 Ctn Size	56.5x29x36 (cm)
螺母规格 Nut Size	M3.5/M4



型号 Code	CA006
产品名称 Name	175x86x39
产品尺寸 Size	175x86x39 (mm)
装箱数 Pcs/Ctn	100 (pcs)
纸箱尺寸 Ctn Size	45x30.5x33.5 (cm)
螺母规格 Nut Size	M3.5/M4



型号 Code	CA012
产品名称 Name	168x75x50
产品尺寸 Size	168x75x50 (mm)
装箱数 Pcs/Ctn	100 (pcs)
纸箱尺寸 Ctn Size	42.5x38x35.5 (cm)
螺母规格 Nut Size	M3.5/M4



型号 Code	CA013
产品名称 Name	168x75x55
产品尺寸 Size	168x75x55 (mm)
装箱数 Pcs/Ctn	50 (pcs)
纸箱尺寸 Ctn Size	40.5x33.5x25 (cm)
螺母规格 Nut Size	M3.5/M4



型号 Code	CA019
产品名称 Name	210X180X60
产品尺寸 Size	210X180X60 (mm)
装箱数 Pcs/Ctn	20 (pcs)
纸箱尺寸 Ctn Size	110.7x34.7x42.7 (cm)
螺母规格 Nut Size	M4



型号 Code	CA014
产品名称 Name	255X75X50
产品尺寸 Size	255X75X50 (mm)
装箱数 Pcs/Ctn	50 (pcs)
纸箱尺寸 Ctn Size	62.5x40.5x30.5 (cm)
螺母规格 Nut Size	M3.5/M4



型号 Code	CA020
产品名称 Name	225X150X 60
产品尺寸 Size	225X150X 60 (mm)
装箱数 Pcs/Ctn	30 (pcs)
纸箱尺寸 Ctn Size	72.5x32x32.5 (cm)
螺母规格 Nut Size	M4



型号 Code	CA015
产品名称 Name	108X108X 60
产品尺寸 Size	108X108X 60 (mm)
装箱数 Pcs/Ctn	50 (pcs)
纸箱尺寸 Ctn Size	60x23x33.5 (cm)
螺母规格 Nut Size	M4



型号 Code	CA021
产品名称 Name	225X150X 80
产品尺寸 Size	225X150X 80 (mm)
装箱数 Pcs/Ctn	30 (pcs)
纸箱尺寸 Ctn Size	72.5x32x40.5 (cm)
螺母规格 Nut Size	M4



型号 Code	CA016
产品名称 Name	155X155X 60
产品尺寸 Size	155X155X 60 (mm)
装箱数 Pcs/Ctn	50 (pcs)
纸箱尺寸 Ctn Size	84x33.5x27.5 (cm)
螺母规格 Nut Size	M4



型号 Code	CA022
产品名称 Name	230X230X100
产品尺寸 Size	230X230X100 (mm)
装箱数 Pcs/Ctn	10 (pcs)
纸箱尺寸 Ctn Size	48.5x24.5x56.5 (cm)
螺母规格 Nut Size	M4



型号 Code	CA017
产品名称 Name	155X155X 80
产品尺寸 Size	155X155X 80 (mm)
装箱数 Pcs/Ctn	40 (pcs)
纸箱尺寸 Ctn Size	67.5x33x39.5 (cm)
螺母规格 Nut Size	M4



型号 Code	CA023
产品名称 Name	260X210X80
产品尺寸 Size	260X210X80 (mm)
装箱数 Pcs/Ctn	10 (pcs)
纸箱尺寸 Ctn Size	83.5x26x44.5 (cm)
螺母规格 Nut Size	M4



型号 Code	CA018
产品名称 Name	180X120X 60
产品尺寸 Size	180X120X 60 (mm)
装箱数 Pcs/Ctn	30 (pcs)
纸箱尺寸 Ctn Size	56x30x32 (cm)
螺母规格 Nut Size	M4



型号 Code	CA024
产品名称 Name	305X308X100
产品尺寸 Size	305X308X100 (mm)
装箱数 Pcs/Ctn	10 (pcs)
纸箱尺寸 Ctn Size	62x31x53.5 (cm)
螺母规格 Nut Size	M4

Electrical Accessories Series

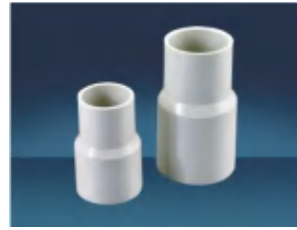

型号 Code	产品名称 Name	尺寸 Size	装箱数 Pcs/Ctn	纸箱尺寸 Ctn Size	螺母 Nut Size
CA032	异径直通	φ 20	100/1000	40.5X24X28.5	
		φ 25	100/1000	55.5X32.5X31.5	



型号 Code	产品名称 Name	尺寸 Size	装箱数 Pcs/Ctn	纸箱尺寸 Ctn Size	螺母 Nut Size
CA036	带盖弯头	φ 20	20/500	72x35.5x30.5	
		φ 25	20/500	80.5x40.5x38.5	



型号 Code	产品名称 Name	尺寸 Size	装箱数 Pcs/Ctn	纸箱尺寸 Ctn Size	螺母 Nut Size
CA033	90度弯头	φ 16	300	36.5X20X11	
		φ 20	200	36.5X20X11	
		φ 25	100	38.5X21X13.2	
		φ 32	40	36.5X20X11	
		φ 40	30	38.5X21X13.2	
φ 50	15	36.5X20X11			



型号 Code	产品名称 Name	尺寸 Size	装箱数 Pcs/Ctn	纸箱尺寸 Ctn Size	螺母 Nut Size
CA037	大弧度弯	φ 16	100/100	61.5x29x11	
		φ 20	100/500	65x33.5x26	
		φ 25	100/500	76.5X34.5X36.5	



型号 Code	产品名称 Name	尺寸 Size	装箱数 Pcs/Ctn	纸箱尺寸 Ctn Size	螺母 Nut Size
CA034	T型三通	φ 16	300	38.5X21X13.2	
		φ 20	200	38.5X21X13.2	
		φ 25	100	38.5X21X13.2	
		φ 32	40	38.5X21X13.2	
		φ 40	30	38.5X21X13.2	
φ 50	15	38.5X21X13.2			



型号 Code	产品名称 Name	尺寸 Size	装箱数 Pcs/Ctn	纸箱尺寸 Ctn Size	螺母 Nut Size
CA038	带柄管夹	φ 20	100/1000	44x25x28	
		φ 25	100/1000	44x25x28	



型号 Code	产品名称 Name	尺寸 Size	装箱数 Pcs/Ctn	纸箱尺寸 Ctn Size	螺母 Nut Size
CA035	带盖T型三通	φ 20	20/400	55.5x24.5x33.5	
		φ 25	20/400	54.5x35x35.5	



型号 Code	产品名称 Name	尺寸 Size	装箱数 Pcs/Ctn	纸箱尺寸 Ctn Size	螺母 Nut Size
CA039	管接头	φ 20	100/2000	52.5x25x47	
		φ 25	100/1000	55.5x30.5x31.5	



ITEM NO.:	FA001
PRODUCT NAME:	New 3"X3" Cable Box
SIZE:	86x86x30
QTY/CTN (PCS):	200
CARTON SIZE:	40.5x35.5x30
NUT SIZE:	M3.5/M5



ITEM NO.:	FA003
PRODUCT NAME:	3"X6" Cable Box
SIZE:	145x85x36
QTY/CTN (PCS):	100
CARTON SIZE:	38.5x35.5x28.5
NUT SIZE:	M3.5/M5



ITEM NO.:	FA002
PRODUCT NAME:	3"X3" Cable Box
SIZE:	86x86x30
QTY/CTN (PCS):	200
CARTON SIZE:	40.5x35.5x30
NUT SIZE:	M3.5/M5



ITEM NO.:	FA004
PRODUCT NAME:	3"X3" Switch Box
SIZE:	72x72x36
QTY/CTN (PCS):	200
CARTON SIZE:	38.5x38.5x30.5
NUT SIZE:	M3.5/M5



ITEM NO.:	FA005
PRODUCT NAME:	3"X6" Switch Box
SIZE:	136x72x40
QTY/CTN (PCS):	100
CARTON SIZE:	60.5x27.5x22.5
NUT SIZE:	M3.5/M5



ITEM NO.:	FA011
PRODUCT NAME:	4 Way Box
SIZE:	φ 20 φ 25
QTY/CTN (PCS):	20/400 20/400
CARTON SIZE:	76x43x38 78.5x43x40
NUT SIZE:	M4/M5 M4/M5



ITEM NO.:	FA006
PRODUCT NAME:	Looping Box
SIZE:	φ 20 φ 25
QTY/CTN (PCS):	20/400 20/400
CARTON SIZE:	56.5x34x38 56.5x34x38
NUT SIZE:	M4/M5 M4/M5



ITEM NO.:	FA012
PRODUCT NAME:	U Way Box
SIZE:	φ 20 φ 25
QTY/CTN (PCS):	20/400 20/400
CARTON SIZE:	74.5x34x38 74.5x35x40
NUT SIZE:	M4/M5 M4/M5



ITEM NO.:	FA007
PRODUCT NAME:	Stopend Box
SIZE:	φ 20 φ 25
QTY/CTN (PCS):	20/400 20/400
CARTON SIZE:	62x35x38 66x35x40
NUT SIZE:	M4/M5 M4/M5



ITEM NO.:	FA013
PRODUCT NAME:	Y Way Box
SIZE:	φ 20 φ 25
QTY/CTN (PCS):	20/400 20/400
CARTON SIZE:	82.5x35.5x38 82.5x35.5x40
NUT SIZE:	M4/M5 M4/M5



ITEM NO.:	FA008
PRODUCT NAME:	Through Way Box
SIZE:	φ 20 φ 25
QTY/CTN (PCS):	20/400 20/400
CARTON SIZE:	76.8x33.5x38 72.5x37x40
NUT SIZE:	M4/M5 M4/M5



ITEM NO.:	FA014
PRODUCT NAME:	H Way Box
SIZE:	φ 20
QTY/CTN (PCS):	20/400
CARTON SIZE:	82.5x35.5x38
NUT SIZE:	M4/M5



ITEM NO.:	FA009
PRODUCT NAME:	Two Way Box
SIZE:	φ 20 φ 25
QTY/CTN (PCS):	20/400 20/400
CARTON SIZE:	63.5x38.5x38 69.5x39x40
NUT SIZE:	M4/M5 M4/M5



ITEM NO.:	FA015
PRODUCT NAME:	4 Step Box
SIZE:	φ 20
QTY/CTN (PCS):	20/400
CARTON SIZE:	69x57.5x34.5
NUT SIZE:	M4/M5



ITEM NO.:	FA010
PRODUCT NAME:	Tee Way Box
SIZE:	φ 20 φ 25
QTY/CTN (PCS):	20/400 20/400
CARTON SIZE:	62.5x44x38 64.5x44x40
NUT SIZE:	M4/M5 M4/M5



ITEM NO.:	FA016
PRODUCT NAME:	Round Cover Box
SIZE:	65X65X2
QTY/CTN (PCS):	100/1000
CARTON SIZE:	68x14.5x15
NUT SIZE:	

Electrical Accessories Series



ITEM NO.:	FA017
PRODUCT NAME:	3" X 3" Flat Cover
SIZE:	86X86X2
QTY/CTN (PCS):	100/1000
CARTON SIZE:	53x19x21
NUT SIZE:	

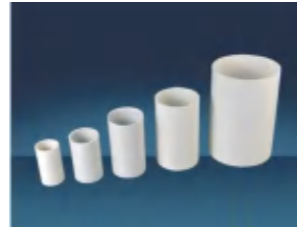

ITEM NO.	PRODUCT NAME	SIZE	QTY/CTN (PCS)	CARTON SIZE	NUT SIZE
FA023	Coupler	φ 16	300	32.5X17.5X9.5	
		φ 20	100/2000	52.5x25x47	
		φ 25	100/1000	55.5x30.5x31.5	
		φ 32	100/1000	62.5x24.5x33.5	

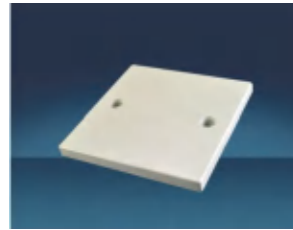

ITEM NO.:	FA018
PRODUCT NAME:	3" X 3" Cover
SIZE:	86X86X4
QTY/CTN (PCS):	100/1000
CARTON SIZE:	62.5x33.5x42.5
NUT SIZE:	



ITEM NO.:	FA024
PRODUCT NAME:	4"X 4" Switch Box
SIZE:	108X108X60
QTY/CTN (PCS):	50
CARTON SIZE:	60x23x33.5
NUT SIZE:	M4

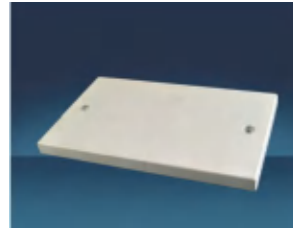

ITEM NO.:	FA019
PRODUCT NAME:	3" X 6" Cover
SIZE:	145x86x8
QTY/CTN (PCS):	100/1000
CARTON SIZE:	93x31x49
NUT SIZE:	



ITEM NO.:	FA025
PRODUCT NAME:	6"X 6"X2" Switch Box
SIZE:	155X155X 50
QTY/CTN (PCS):	50
CARTON SIZE:	84x33.5x27.5
NUT SIZE:	M4

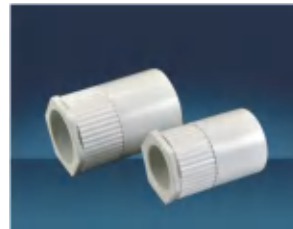

ITEM NO.:	FA020
PRODUCT NAME:	Male Bush
SIZE:	φ 20 φ 25
QTY/CTN (PCS):	100/2000 100/1000
CARTON SIZE:	50.5x25x42 48x30.5x31.5
NUT SIZE:	



ITEM NO.:	FA026
PRODUCT NAME:	6"X 6" X3" Switch Box
SIZE:	155X155X 80
QTY/CTN (PCS):	40
CARTON SIZE:	67.5x33x39.5
NUT SIZE:	M4



ITEM NO.	PRODUCT NAME	SIZE	QTY/CTN (PCS)	CARTON SIZE	NUT SIZE
FA021	"U" Conduit Clip	φ 16	100/1000	43x17x28	
		φ 20	100/1000	43x17x28	
		φ 25	100/1000	44x25x28	
		φ 32	100/1000	37x31x32	
		φ 40	100/1000	37x31x32	



ITEM NO.:	FA027
PRODUCT NAME:	6"X 9" X2" Switch Box
SIZE:	225X150X60
QTY/CTN (PCS):	30
CARTON SIZE:	72.5x32x32.5
NUT SIZE:	M4



ITEM NO.	PRODUCT NAME	SIZE	QTY/CTN (PCS)	CARTON SIZE	NUT SIZE
FA022	"N" Saddle Clip	φ 20	100/1000	49x34x24	M3.5
		φ 25	100/1000	49x34x24	M3.5
		φ 32	100/1000	49x34x24	M3.5



ITEM NO.:	FA028
PRODUCT NAME:	6"X 9" X3" Switch Box
SIZE:	225X150X80
QTY/CTN (PCS):	30
CARTON SIZE:	72.5x32x40.5
NUT SIZE:	M4



ITEM NO.:	FA029
PRODUCT NAME:	9"X 9" X3" Switch Box
SIZE:	230X230X100
QTY/CTN (PCS):	10
CARTON SIZE:	48.5x24.5x56.5
NUT SIZE:	M4



ITEM NO.:	FA030
PRODUCT NAME:	12"X 12" X3" Switch Box
SIZE:	305X308X100
QTY/CTN (PCS):	10
CARTON SIZE:	62x31x53.5
NUT SIZE:	M4

型号	相片	产品尺寸	材料/颜色	装箱数
Item NO.	Photo	Size(mm)	Material / Colour	QTY/CTN (pcs)
1	A	12*12	PVC / White	200/2000
2		15*10	PVC / White	200/2000
3		16*16	PVC / White	200/2000
4		20*10	PVC / White	100/2000
5		24*14	PVC / White	100/2000
6		25*16	PVC / White	100/2000
7	B	25*25	PVC / White	100/2000
8		39*19	PVC / White	100/2000
9		40*16	PVC / White	100/2000
10		40*25	PVC / White	100/2000
11		40*40	PVC / White	
12		50*25	PVC / White	
13	C	50*50	PVC / White	
14		59*22	PVC / White	50/500
15		60*40	PVC / White	50/500
16		60*60	PVC / White	
17		75*25	PVC / White	
18		75*50	PVC / White	
19	D	75*75	PVC / White	
20		80*40	PVC / White	
21		80*50	PVC / White	
22		80*60	PVC / White	
23		80*75	PVC / White	
24		80*80	PVC / White	
25	E	100*27	PVC / White	20/100
26		100*40	PVC / White	20/100
27		100*50	PVC / White	20/100
28		100*60	PVC / White	20/100
29		100*75	PVC / White	
30		100*80	PVC / White	
31		100*100	PVC / White	20/100

■ 波纹管系列

Flexible Hose Series
FLEXIBLE HOSE COLOR IS AVAILABLE FOR WHITE, BLACK AND GREY, WHICH ARE REQUIRED BY CUSTOMER.

型号 Model	规格 Size(mmxmm)	包装 Package(m)	型号 Model	规格 Size(mmxmm)	包装 Package(m)
YSF16	Φ16	50	YSF32	Φ32	50
YSF20	Φ20	50	YSF40	Φ40	50
YSF25	Φ25	50	YSF50	Φ50	50