

Specification Sheet

Picture:



Product size:

Name: ----- Windsor 5 Pendant
Code: ----- 3425
Finish: ----- Polished
Main Material: --- Stainless steel
+ Steel
Shade Material: -- Fabric+PVC

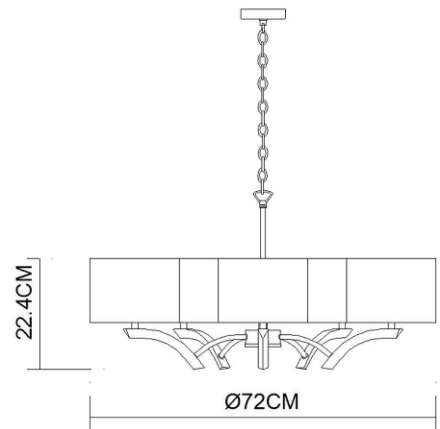

Lamp Source: E14

Wattage: 5x40W / 5x9W

Input Voltage: 220~240 V

Lumen: 1700 lm

Switch: Na

Energy Efficiency Class:

Plug: Na

Specification:



Inner Box:

Gross Weight: 12.5KGS

750*210*740(mm) 1pc

Net Weight: KGS

Outer Carton:

765*755*440(mm) 2pcs

Cable Length / Terminal Block:

Installation Instruction:

