

# TRAILER HOUSE





About us

# 佛山市南海国色 智能化设备有限公司

Foshan Nanhai Goose Intelligent Facilities Co., Ltd.

佛山市南海国色智能化设备有限公司  
Foshan Goose Intelligent Facilities Co., Ltd.





## About us



Laser cutting machine



Welding of main steel frame



Hydraulic CNC bending machine



Electroplating and painting

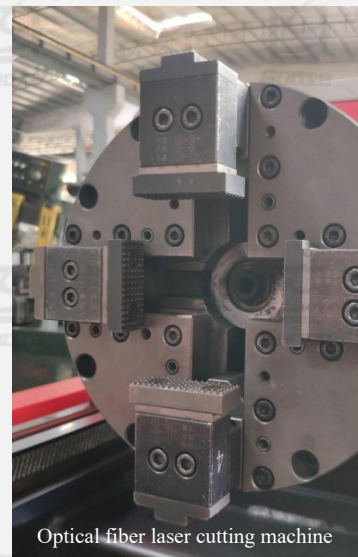

Optical fiber laser cutting machine



## Product Information

Product size: 8000\*2500\*4000mm

Dry area: 20 SQM

Load: 3.5 tons

Layout: 1 living room, 1 bedroom, 1 kitchen and 1 bathroom

Application scenario: Hotel, B&B, cultural tourism housing

Product shipping mode: Disassembled/Assembled





## Interior renderings





# Three views and layout plan

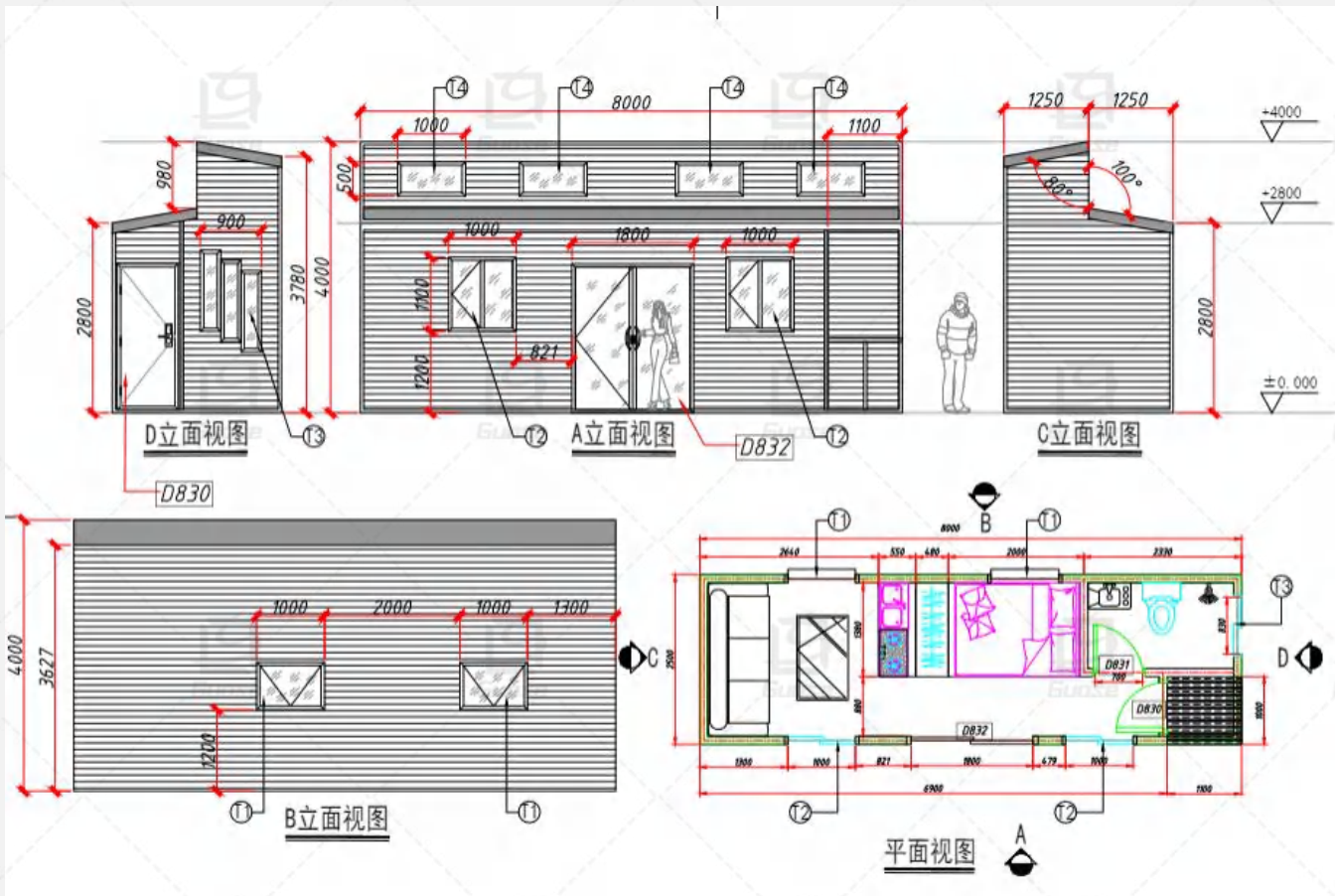



# Production pictures





## Product Information

Product size: 8000\*2500\*4200mm

Living area: 20 SQM

Load: 4 tons

Layout: 1 living room, 1 bedroom, 1 kitchen and 1 bathroom

Application scenario: Hotel, B&B, cultural tourism housing

Product shipping mode: Disassembled/Assembled





# Interior renderings

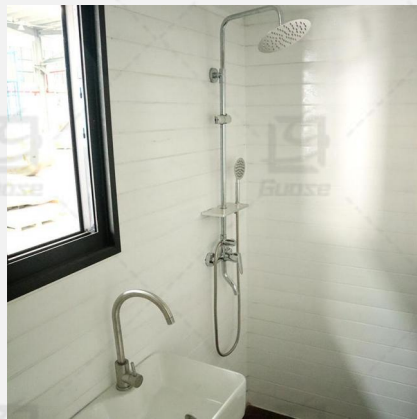
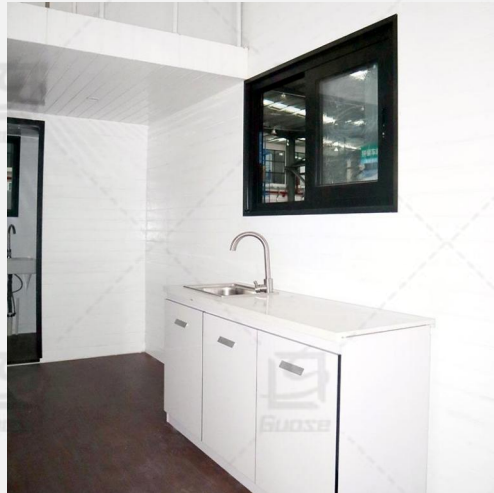
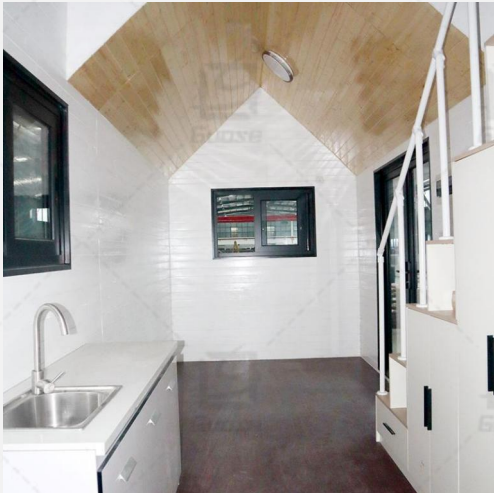

# Three views and layout plan

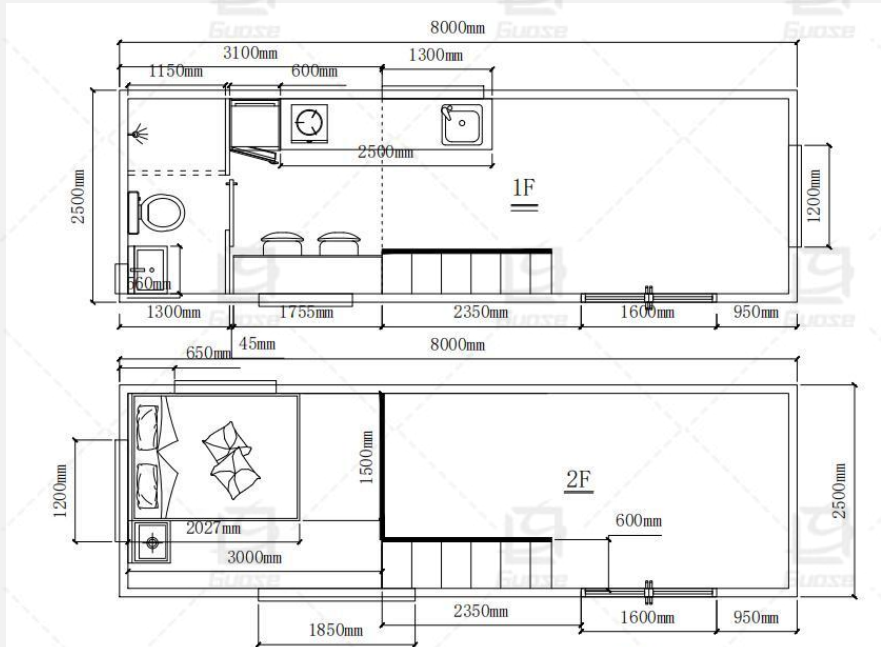
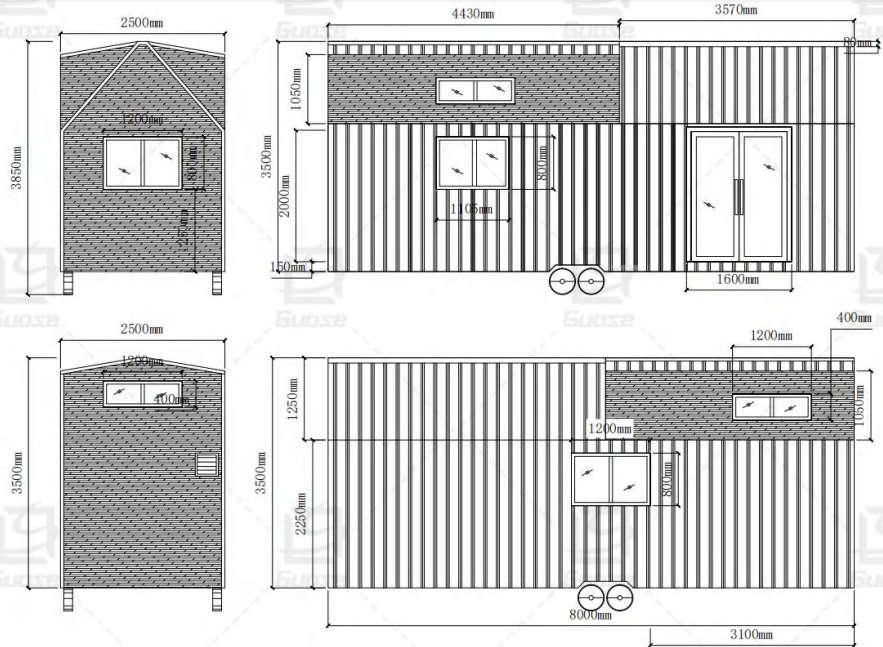



## Production pictures





## Product Information

Product size: 8000\*2500\*3800mm

Layout: 1 living room, 1 bedroom, 1 kitchen and 1 bathroom

Living area: 20 SQM

Application scenario: Hotel, B&B, cultural tourism housing

Load: 3.5 tons

Product shipping mode: Disassembled/Assembled



# Interior renderings





# Three views and layout plan

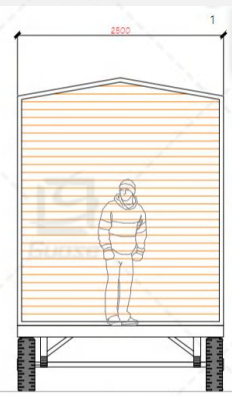
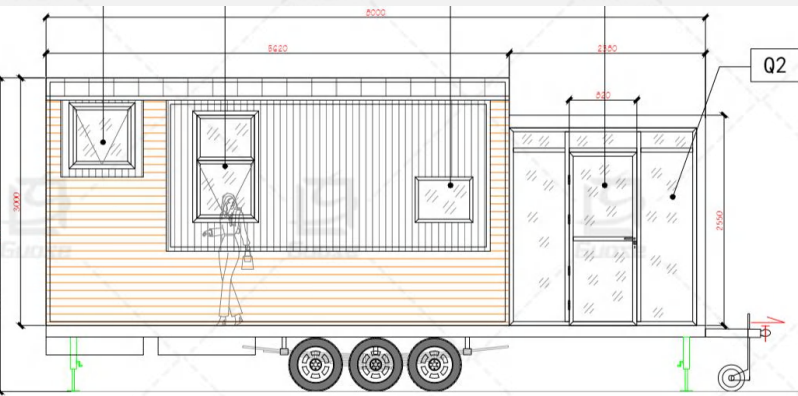
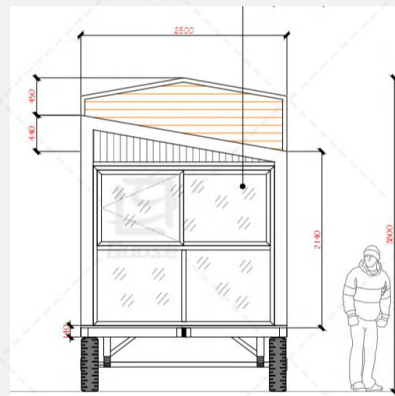
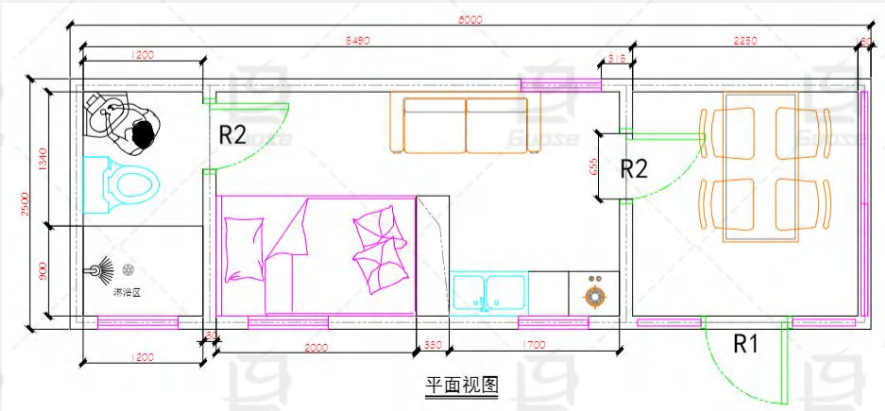
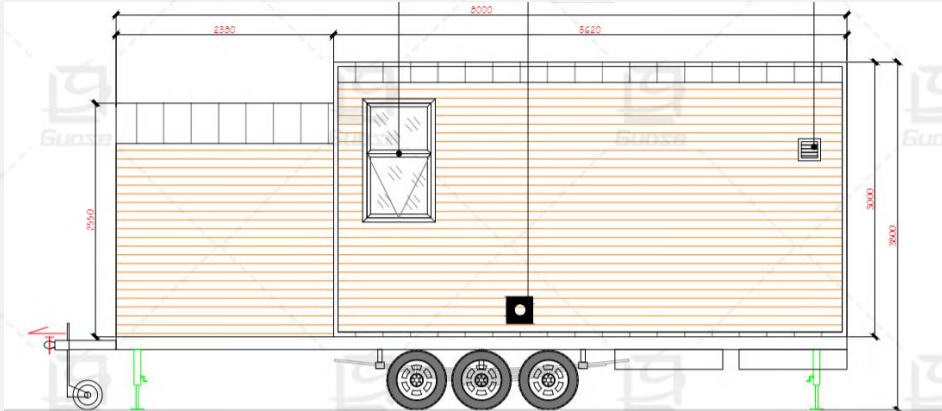

右视图

正视图

左视图



# Production pictures





## Product Information

Product size: 8000\*2500\*4200mm

Layout: 1 living room, 1 bedroom, 1 kitchen and 1 bathroom

Living area: 20 SQM

Application scenario: Hotel, B&B, cultural tourism housing

Load: 4 tons

Product shipping mode: Disassembled/Assembled





## Production pictures





# Three views and layout plan

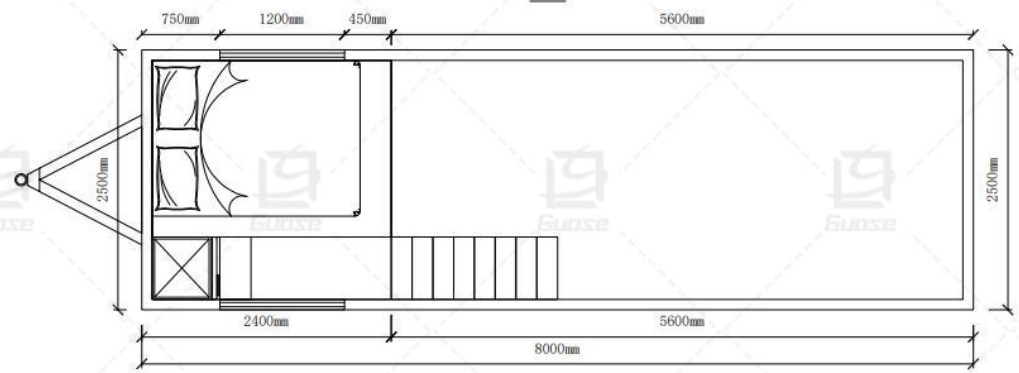
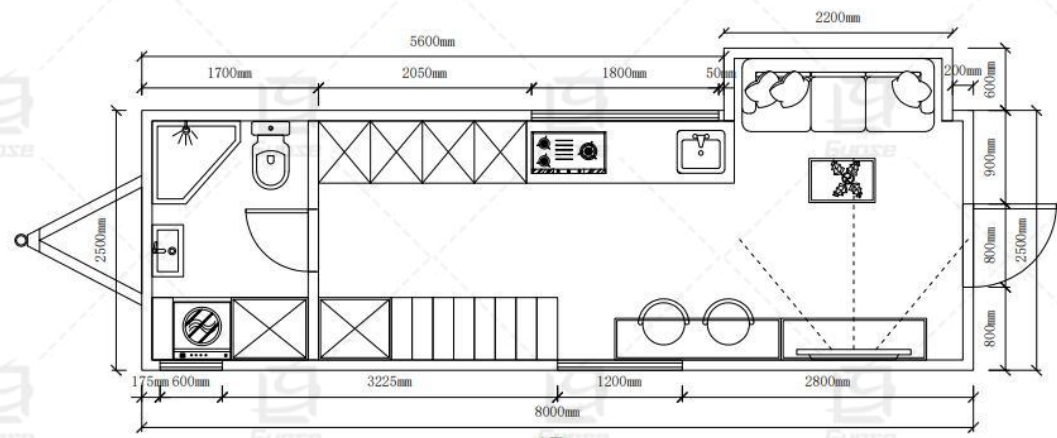



## Product Information

Product size: 9000\*2500\*4200mm

Layout: 1 living room, 1 bedroom, 1 kitchen and 1 bathroom

Living area: 22.5 SQM

Application scenario: Hotel, B&B, cultural tourism housing

Load: 4 tons

Product shipping mode: Disassembled/Assembled



## Production pictures





# Three views and layout plan

## Single Loft

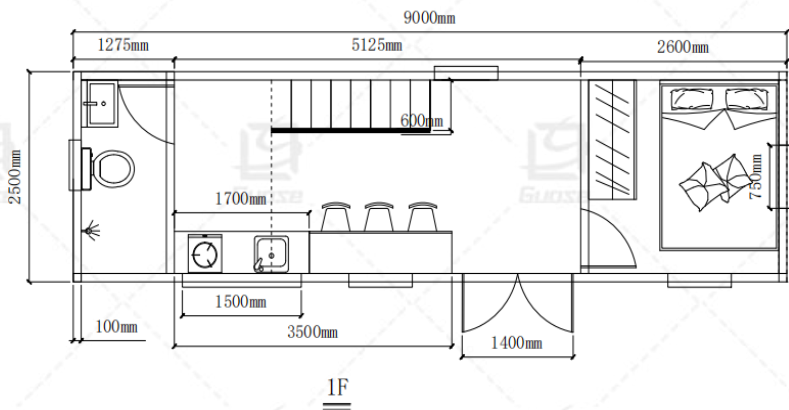
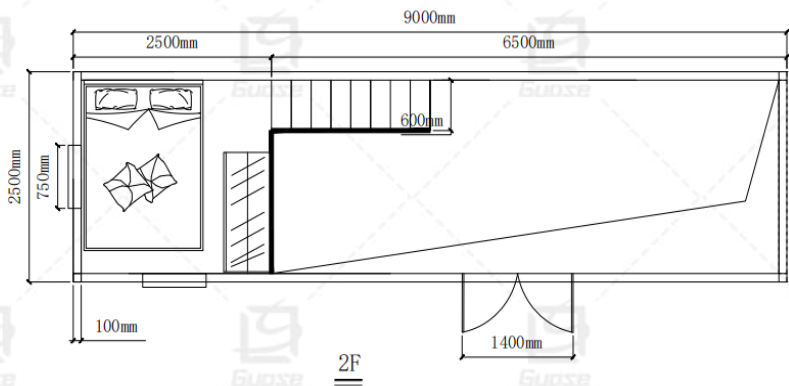

## Double Loft

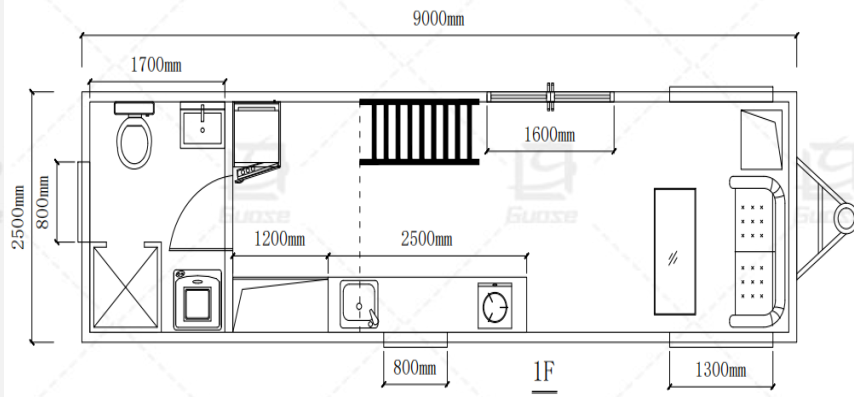
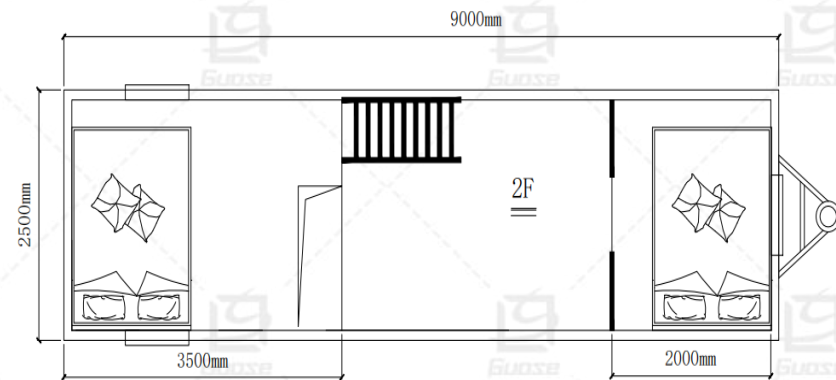



## Product Information

Product size: 5800\*2250\*4000mm

Layout: 1 living room, 1 bedroom, 1 kitchen and 1 bathroom

Living area: 13 SQM

Application scenario: Hotel, B&B, cultural tourism housing

Load: 2 tons

Product shipping mode: Disassembled/Assembled



## Production pictures





# Three views and layout plan

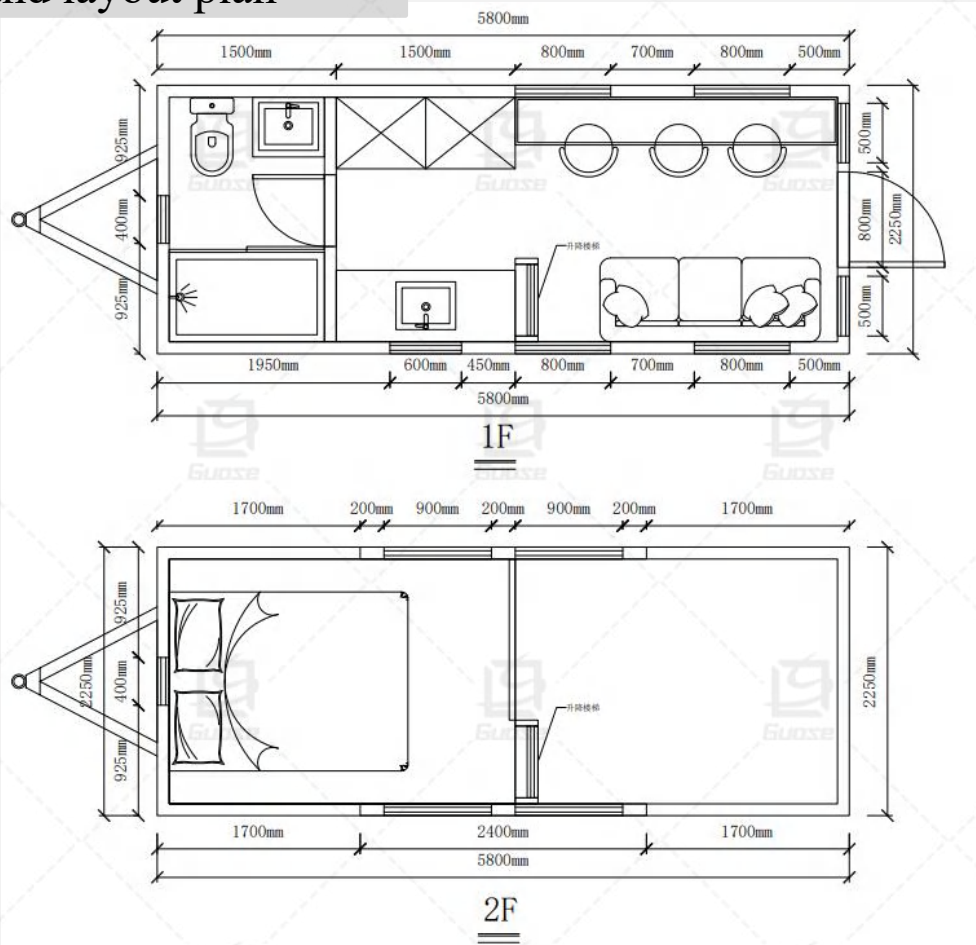





## Product Information

Product size: 8000\*2500\*4200mm

Living area: 20 SQM

Load: 3.5 tons

Layout: 1 living room, 1 bedroom, 1 kitchen and 1 bathroom

Application scenario: Hotel, B&B, cultural tourism housing

Product shipping mode: Disassembled/Assembled



## Interior renderings

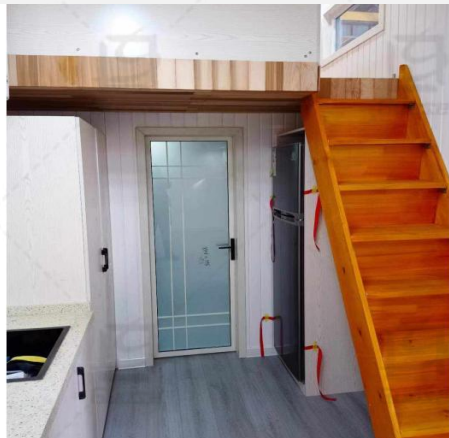



# Layout plan

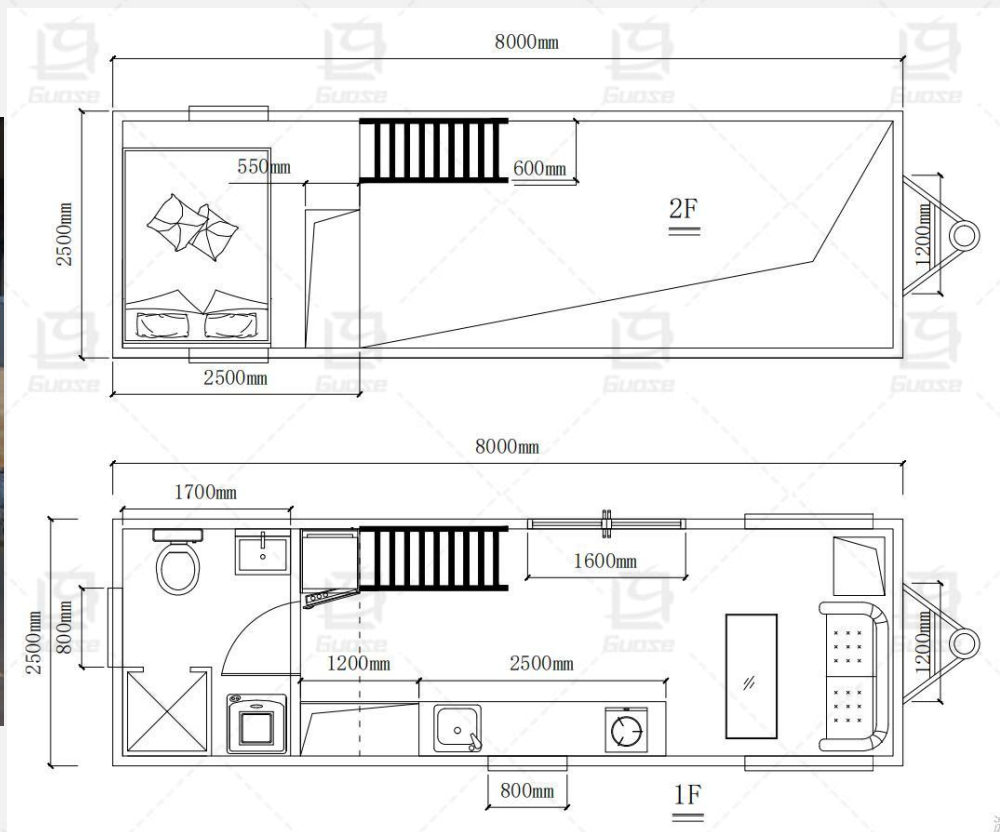



## Product Information

Product size: 9000\*2500\*4200mm

Layout: 1 living room, 1 bedroom, 1 kitchen and 1 bathroom

Living area: 22 . 5 SQM

Application scenario: Hotel, B&B, cultural tourism housing

Load: 4 tons

Product shipping mode: Disassembled/Assembled



# Production pictures





# Three views and layout plan

## Single Loft

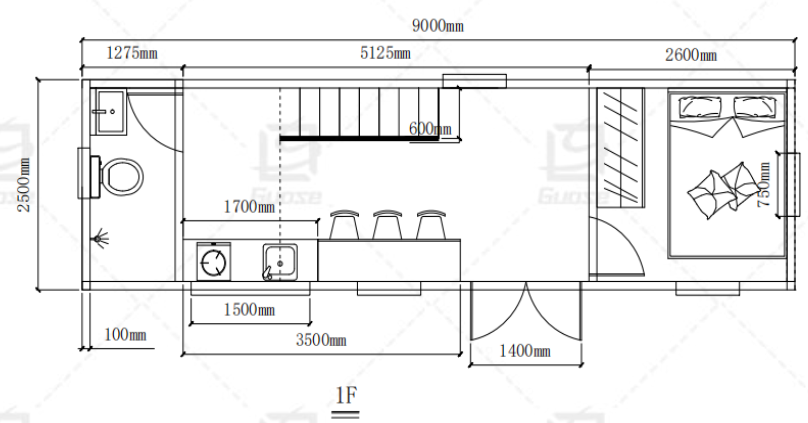
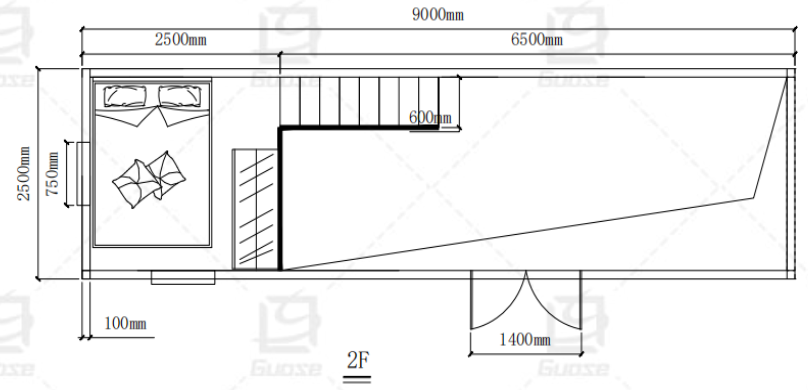

## Double Loft

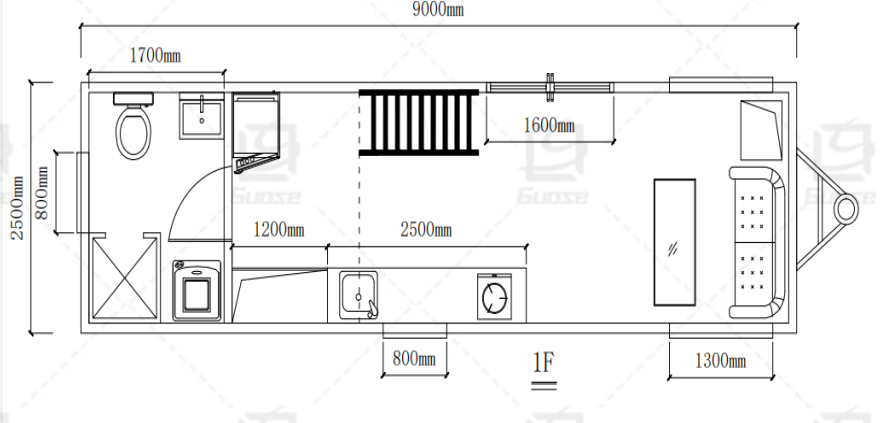
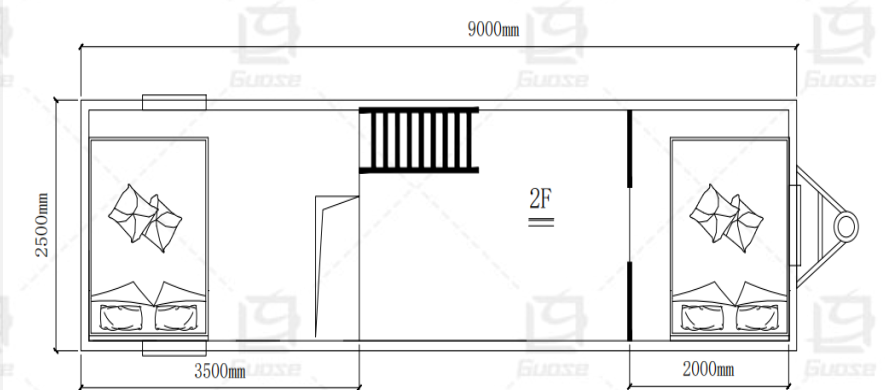

## Shippment -Dismantled

There are two shipping method, one the disassembled and the other one is assembled





## Shipment - Assembled

There are two shipping method, one the disassembled and the other one is assembled

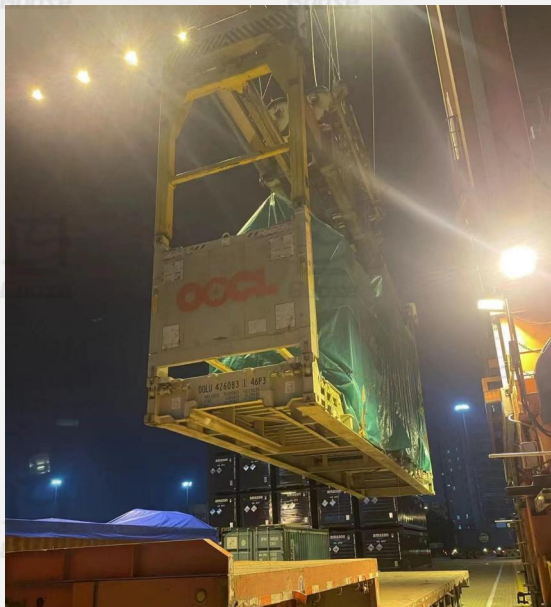





# Trailer Chasis

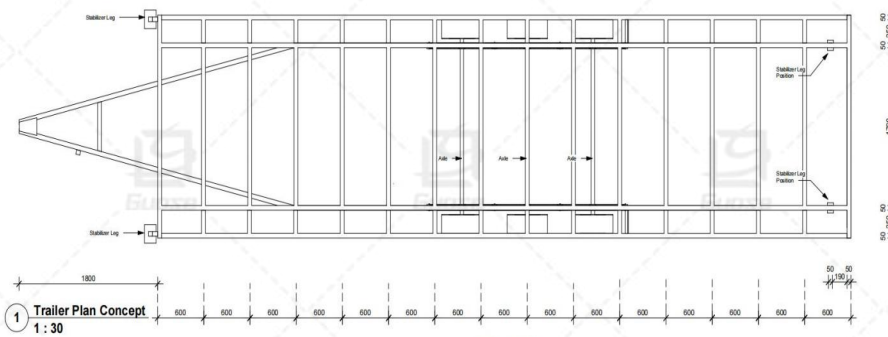
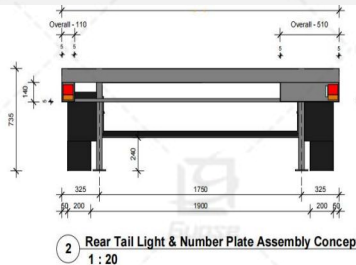

## Chasis system

Off-road version independent suspension

European standard (shock absorption is torsion shaft, mechanical brake)

Australian standard/American standard (shock absorption is leaf spring, electric brake or mechanical brake)

**All layouts and dimensions can be customized.**



# Structure

